

VIGAS

Gasifying boilers

**MANUAL FOR INSTALLATION, ASSEMBLY,
MAINTENANCE AND USE**

Warranty Certificate

**VIGAS and VIGAS Lambda Control
with AK 4000 control**



VIMAR 2013

Content	Page
Declaration of conformity.....	3
1. Technical description.....	4
2. Technical data.....	5
3. AK 4000 control description.....	7
4. VIGAS boiler - basic configuration.....	9
5. VIGAS boiler - discharge fan configuration.....	10
6. VIGAS <small>Lambda Control</small> – basic configuration.....	11
7. Kotel VIGAS <small>Lambda Control</small> - discharge fan configuration.....	13
8. Temperature setting.....	14
9. Parametres setting.....	15
10. Time set-up.....	16
11. Harware and software information.....	16
12. Error notification.....	16
13. Configuration setting using PIN 0000.....	17
14. Operating instructions.....	22
15. Boiler maintenance and repairs.....	24
16. Boiler accessories and assembly.....	26
17. Service departments.....	27
18. Problems, cause and solution.....	28
19. Installation instruction.....	30
Electric scheme	32
VIGAS Warranty certificate.....	33
VIGAS Commission certificate	33



DECLARATION OF CONFORMITY

Issued according to § 12 sec. 3 let. a) Act. No. 264/1999 Coll
a 97 / 23 EC

We, Pavel Vigaš - VIMAR,

M. Čulena 25
974 11 Banská Bystrica
SLOVAKIA
VAT no. SK1020548001
Reg. No. 17956145

hereby declare, that the undermentioned products comply with technical regulations and the products are safe if determined conditions are followed and we took all possible measures to assure the compliance of productst with technical documentation, as well as, relevant instruction requirements og government. The validity of this statement is abolished when an unauthorized changes are made without permission of VIMAR.

Product: Thermal boiler VIGAS a VIGAS Lambda Control with AK4000 control

Type: VIGAS 16, VIGAS 16 Lambda Control , VIGAS 25, VIGAS 25 Lambda Control
VIGAS 40, VIGAS 40 Lambda Control , VIGAS 60, VIGAS 60 Lambda Control
VIGAS 80, VIGAS 80 Lambda Control , VIGAS 100, VIGAS 100 Lambda Control
VIGAS 29 UD

Producer: Pavel Vigaš - VIMAR
M. Čulena 25, 974 11 Banská Bystrica,
SLOVAKIA

Competent statutory codes (CSC)

CSC no. 576/2002 C.s. – Pressure Equipment Directive (97/23/EC)
CSC no. 308/2004 C.s. – Low voltage electric devices (2006/95/ES)
CSC no. 194/2005 C.s. – Electromagnetic Compatibility Directive (2004/108/EC)

Used harmonized standards for CE marking

STN EN 303-5: 2012; STN EN 60335-1: 2012; STN EN 60335-2-102 : 2007
STN EN 61000-6-3: 2007; STN EN 55014-1: 2007; STN EN 61000-3-2: 2006
STN EN 61000-3-3: 2009; STN EN 61000-6-2: 2006

Additional data: Certificates

Design examination Certificate No.812990017, No. 812990016, Certificate
No.0021/104/2/2010, Certificate No. 0023/104/2/2010, Certificate No. 0029/104/2/2009,
Certificate No. 812990019, Certificate No. 101299028

CE marking was proceed according to § 12, par. 3 letter a) Act. No. 264/1999 Coll.

Issued in: Banská Bystrica

Name: VIGAŠ Pavel

Date of issue: 1.4.2013

Title:

Owner

Signature:

1. TECHNICAL DESCRIPTION

Thermal boilers VIGAS are designed for combustion of dry wood materials, using sawdust to wood logs according to the dimension of gasification chamber, with maximum diameter of 20 cm. Sawdust, woodchips, splinters and cuttings must be burn together with wood logs. Thermal boiler VIGAS 29 UD is designed to burn brown coal. It is possible to use dry wooden material as a substitute fuel.

Boilers are welded from 4 – 6 mm steel sheets. Inner boiler sheets, which are in contact with boiler waste gases are 6 mm thick, others are made of 4 mm steel.

Heat exchanger is welded from steel pipes, 57x4,5 mm. Exterior boiler panels are made of 0,8 mm sheet. Thermal insulation of the boiler is made of isolation material, NOBASIL 20 and 50 mm thickness. Combustion gases are lead through steel boiler neck to the chimney.

The boiler space consists of combustion chamber, where fuel is dried and gasified. Then accrued gas gets through fireproof /concrete, cast iron / nozzle into combustion chamber, where it burns with help of secondary air. Flue gases are intensively cooled in the exchanger. Unburned waste must be removed from combustion chamber. The boiler has a light up damper controlled by rod at the front of the boiler.

In order, the boiler complies with the requirements for non-demanding operation it is equipped with AK4000 control located on the top panel of the boiler. Designed system allows very effective combustion of various kinds of fuel. Control AK4000 with graphical display in basic configuration allows :

- to control temperature of heated water in range 70 - 85°C
- continuous and automatic control of fan according to required output and kind of fuel
- connect and control discharge fan
- connect and control circulation pump
- to connect gases thermometer
- connect room thermostat (room temperature regulator is voltage free)
- to connect extended regulation (Expander AK 4000) via BH BUS
- to connect module AK 4000M data back-up, followed by PC evaluation
- graphical scheme indicating hydraulic boiler connection as requested
- real time set

Configuration VIGAS Lambda Control offers :

- to control the servo flap of primary and secondary air based on data received from lambda sensor oxygen level reading
- during power cut, AA battery types will close servo-operated flap and prevent boiler from natural burning of boiler without chimney draught

The boilers are equipped with thermal fuse STB, which ensures disconnection of the boiler fan, if overheated above 100°C and exchanger safety to prevent boiler against overheating by standards, STN EN 303-5: 2012. Producer recommends to purchase safety valve TS 131 ¾“ and install to exchanger to avoid overheating.

2. TECHNICAL DATA

Chart.1

THERMAL BOILERS														
VIGAS		16	16 LC	25	25 LC	40	40 LC	60	60 LC	80	80 LC	100	100 LC	UD 29
Nominal boiler output	kW	16		25		40		60		80		100		29
Boiler class acc. to EN 303-5: 2012		3	5	3	3	3	5	3	5	3	5	3	5	3
Max. operating pressure	bar	3												
Fuel		Wood, max. moisture 20% of heat value min. 15 MJ/kg												Brown coal
Output capacity	kW	12 - 18		5 - 31		8 - 41		15 - 72		25 - 92		25-100		8-35(8-29)*
Fuel consumption with nominal output	kg/hrs.	4,5		7,6		11,2		19		25		30,4		7,8 (8,0)*
Alternative fuel		wood waste, wood chips, sawdust, sawdust briquettes, (for UD 29 also wood, max. moisture 20%)												
Chimney draught	mBar	0,20 – 0,25			0,20 – 0,35			0,30 – 0,40			0,20 – 0,25			
Weight	kg	400		430		460		760		930		950		430
Height with control	A mm	1135			1385			1420			1120			
Height of outlet branch	B mm	975		1045		1310				1400				1045
Height of inlet branch	C mm	115			125			215			110			
Height of water-feed valve	D mm	55		60		70				135				55
Height of chimney outlet	E mm	890			1110			1170			890			
Width including rod	F mm	645			785			645						
Width including panels	G mm	590			760			590						
Depth	H mm	840		1070			1260		1650			1070		
Exhaust brand	I mm	240			520			240						
Diameter of chimney outlet	J mm	160			200			160						
Depth from edge	K mm	188		305			880		1210			230		
Spacing of insert	L mm	405			70			350						
Diameter of inlet brand	G				2"									
Diameter of outlet brand	G				2"									
Diameter of water-feed valve	G	½"			¾"			½"						
Water volume	l	60		75		93		180		205		215		75
Gases temperature:														
Nominal output	°C	240												
Minimum output	°C	150												
Gasification chamber dimension - Depth	mm	370		560			750		1150		1090		490/440	
Height	mm	490			750			730			500			
Width	mm	440			575			440						
Gasification chamber dimension (w-h)	mm	435 -255			575 – 318			435 - 255						
Max. fuel weight	kg	20		30		40		80		150		30		
Capacity of chamber	dm ³	80		120		185		315		483		457		105
Noisiness	dB	45		45,5		47,7		51,4		54,2		45,5		
Max. electric input	W	70			140			70						
Voltage/ frequency	V/Hz	230ACV / 50 Hz												
Pressure loss of water :														
☞t 10 °C	mBar	9,70		9,75		10,48		12,77		11,83		11,53		9,97
☞t 20 °C	mBar	1,00		1,05		2,55		3,19		2,96		2,84		1,15
Nominal out burning time	hours	4,5		4,20		4,30		4,20		4,20		4,0		5,60 (4,10)
Heat Exchanger - inlet water temperature - inlet water pressure	°C bar	4 – 15 min 1 – max 4												
Safety		Drain valve for heat exchanger HONEYWELL TS 131 ¾" Opening temperature 95 °C												
		STB fuse, blow temperature 100°C (tolerance: -6 °C - 0 °C)												
Weight flow of gases	kg/s	0,034 – 0,047												

* specification for wood fuels

2.1 DIMENSION CHART AND THE POSITION OF SAFETY PLATE TO PROTECT EASILY INFLAMMABLE FLOOR

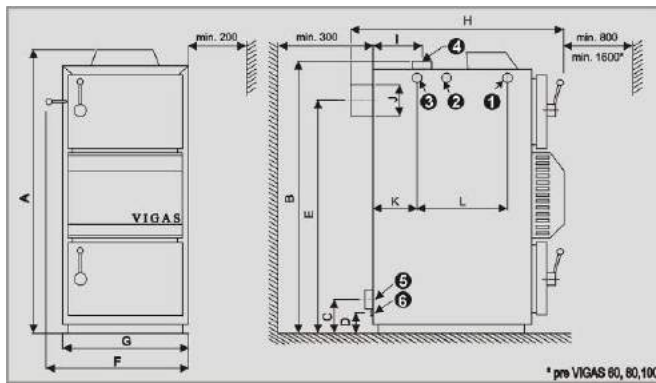

- ① Inlet brand for drain valve
- ② Hole for down valve insert
- ③ Outlet brand of cooling water

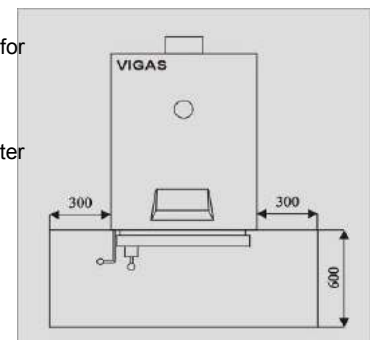

2.2 BOILER SCHEMATICS

Schema VIGAS 16

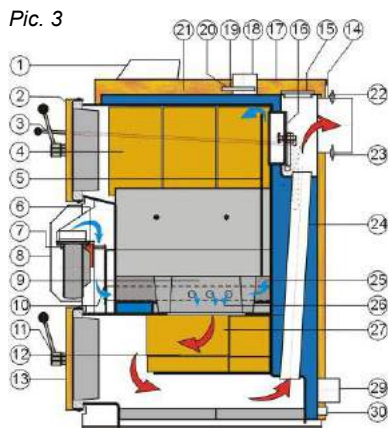

Schema VIGAS 25

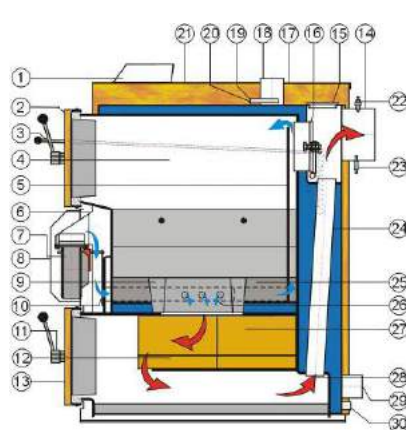

Schema VIGAS 40

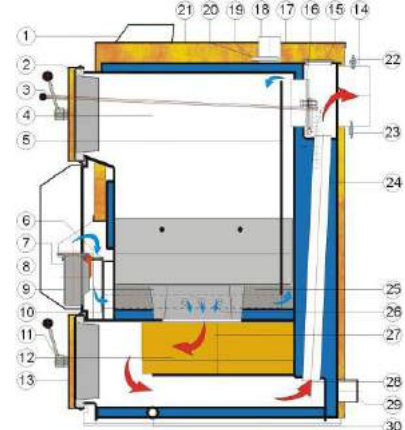

Schema VIGAS 29 UD

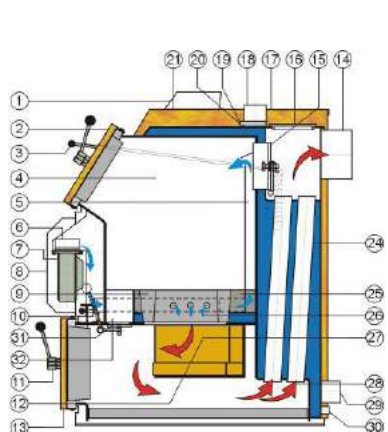

Schema VIGAS 60,80

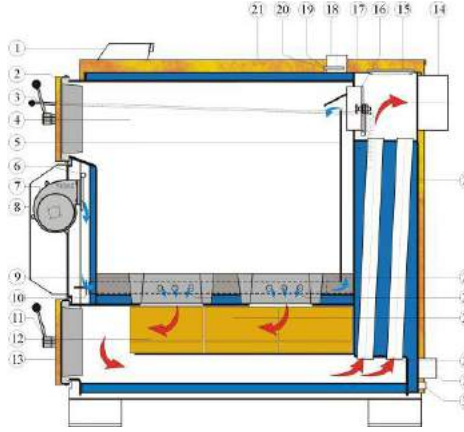

Schema VIGAS 100

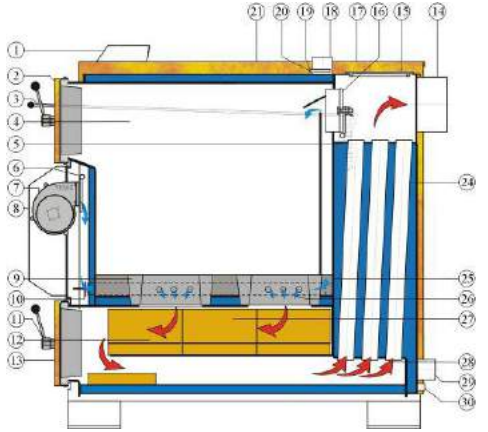

LEGEND		
1. Control AK4000	11. Handle	22. Lambda sonda
2. Upper door	12. Fireclay bricks	23. Gases thermometer
3. Chimney flap operating rod	13. Bottom door	24. Exchanger pipes
4. Chamber area	14. Chimney output	25. Heat proof/concrete filling
5. Primary air conduction	15. Exchanger cover	26. Secondary air
6. Flap for servo Belimo	16. Light up flap	27. Combustion chamber
7. Fan	17. Upper back panel	28. Gases direction
8. Fan cover	18. Water outlet	29. Reverse water leak
9. Nozzle	19. Thermal fuse	30. Filling leak
10. Secondary air flap	20. Thermometer	31. Cleaning flap for 29UD
	21. Upper front panel	32. Cleaning slot for 29UD

3. DESCRIPTION OF AK4000 CONTROL

3.1 SAFETY INSTRUCTIONS

- Please check the cover panels protection before you plug-in the line connector
- Avoid any contact of line connector with boiler hot parts (e.g. smoke flue).
- Make sure, that upper isolation under the panel remains dry (risk of short circuit)
- Do not stress the line connector.
- Always disconnect the line connector when a new electrical components are being connected to the boiler (e.i. indoor room thermostat, discharge fan, circulation pump)
- Do not remove protection (cover panels) when boiler in operating process, especially not fan cover panel.
- Check if voltage displayed on the label is same as your distribution network.
- Always keep to the terms of use.

3.2 CONNECTION TO THE POWER SUPPLY

Control AK 4000 is integral part of VIGAS boilers.

Control is connected when line connector is plugged into the power supply 220/230V. Display with basic image is active when connector line is plugged-in (pic.4). Servo-flap used in VIGAS *Lambda Control* is set to basic position (pic.5).

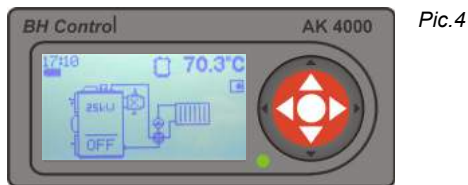

3.3 SERVICE CONDITIONS

Control AK4000 is designed for operation temperature area from +5 up to +45 °C. Control can not be used in moisty environment or direct sunlight.

3.4 MAINTENANCE AK4000 CONTROL

Keep in clean and dust free environment. Antistatic or wet wipes are recommended to wipe-off dust and impurities from metal covers and control panel.

3.5 CONTROL PANEL

The part of this electronic control is panel equipped with buttons, pictograms and display. Further information will be available in the next steps of this manual. The operating system of each button is compound and it depends on the text description on display and particular boiler configuration set up by manufacturer.

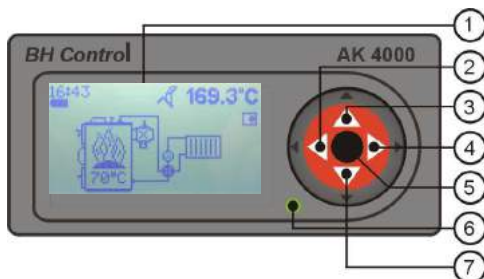

pic.6

1. Graphic display 128 x 64 pix.
2. Button ◀ with functions, ENTER
3. Button ▲ with functions
4. Button ▶ with functions, EXIT (ESC)
5. Button ● (ENTER) with functions
6. LED control (green - OK, red - ERROR)
7. Button ▼ switch functions

Graphic information

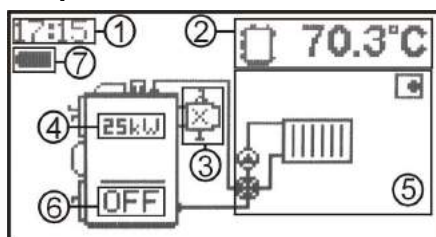





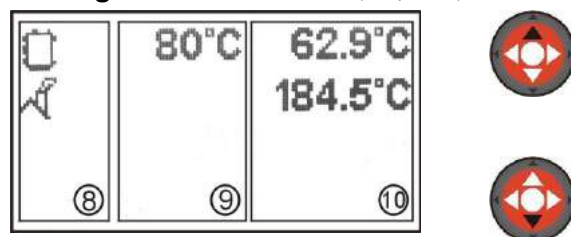









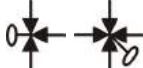

















pic.7

Coding line information (chap.13.5)

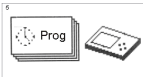

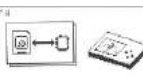
1. Real time indication
2. Coding line – indication of current boiler figures Modification ▲ or=
3. Indication of discharge fan, lambda sensor, gases thermometer
4. Indication of nominal output when boiler is switched off.
5. Graphic indication of hydraulic connection schema.
6. Boiler status indication
7. Battery condition (2 units type AA) used to close servo-flap (only VIGAS Lambda Control)
8. Symbols
9. Set figures
10. Current figures

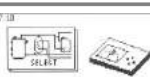
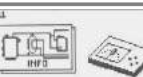
3.6 SYMBOLY

Boiler		Accumulator tank		External boiler	
Boiler „ON“	ON	DUOMIX		Heating Circuit	
Boiler „OFF“	OFF	Valve with servomotor		Indoor thermostat	
Flame up	 ON	Pump		3-way thermostatic valve	
Burning	 73 °C	Discharge fan		LADOMAT	
Afterflaming	 52 °C	Lambda		Fan	
End of burning	END	Thermometer	T	Fan change output	
		External thermometer		Floor heating	
Indoor thermostat decay		Indication figure error	X	Servo-flap position	 servo 50%
Add fuel		Min. exhaust gas figures	min 	Max. exhaust gas figures	max 
Temperature set up		Parameters set up		Time set up	
Error notifications		Programm		Configuration data	
Servise set ups		Memory modul		Motion regulation	
Schemas option		Installation data		Indication option	

4. VIGAS BOILER IN BASIC CONFIGURATION

The advantage of exhaust gas thermometer is control of maximum exhaust gas temperature and when reached by boiler, fan will lower engine RPM. This results in higher boiler effectivity and lower fuel consumption. If installed with accumulator tank, thermometer will shut down boiler when fuel is burned down. The water temperature inside boiler and accumulator tank has no influence on boiler shut down.

4.1 VIGAS BOILER CONTROL

4.1.1 Boiler activation



If the boiler is in switch-off phase, with symbol „OFF“ on the display, to retrieve start press short middle button „ENTER“.

4.1.2 Boiler active – heating phase



In heating phase boiler gas exhaust temperature is lower then set up minimum exhaust gas temperature. Minimum and maximum temperature can be modified in boiler parameters set up. Minimum standard exhaust gas temperature is set up to 50 °C and maximum set up temperature is at 220 °C. The pump works in **pulsating** wave during flame up, depending on the boiler water temperature.

4.1.3 Boiler active – burning phase

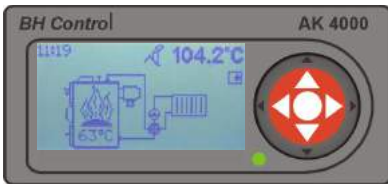

The burning phase is active, when the exhaust gas temperature is (end) +20 °C. The pump works in **pulsating** wave in this phase. If pump symbol is flashing, pump works. Boiler is responsive to the indoor thermostat, when indoor thermostat is switched off, boiler output is slowly reduced.

4.1.4 Add fuel, boiler switch - off (manual control)

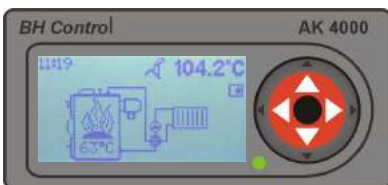

Graphic control is used for this operation. To activate display driver press short middle button „ENTER“. Graphic control offers option to: switch-off boiler, add fuel or cancel display driver.

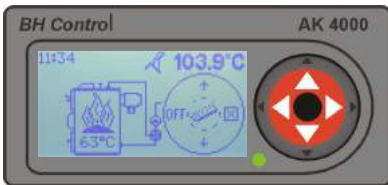

Choose one option	
OFF	Switch off
	Add boiler
<input checked="" type="checkbox"/>	Cancel display driver
	Change indicated figure

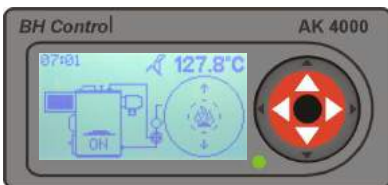
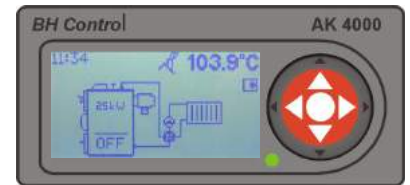

By pressing fan will be switched off. Using the rod open chimney flap, consequently open the upper door. You can add fuel if necessary. After done with reloading close the upper door and chimney flap (pic.12.4). By pressing fuel addition will be ended. Fan will be switched on automatically.



4.1.5 Boiler shut down (automatic)



When exhaust gas temperature drops under the set up temperature (end), the boiler is automatically switched-off. Sign „END“ will be indicated on the display. By pressing 2 times „ENTER“ button boiler will start working again.

5. VIGAS BOILER IN CONFIGURATION WITH DISCHARGE FAN (without lambda sensor)

The advantage of discharge fan installation is increased comfort during boiler flame up and fuel addition. Discharge fan significantly helps to reduce smoke in area during fuel feed. In flame-up phase helps to create quickly heated fuel layer.

5.1 VIGAS BOILER CONTROL

5.1.1 Boiler activation

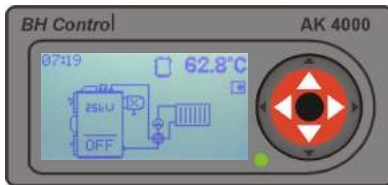

If the boiler is in switch-off phase, with symbol „OFF“ on the display, to retrieve start press short middle „ENTER“ button.

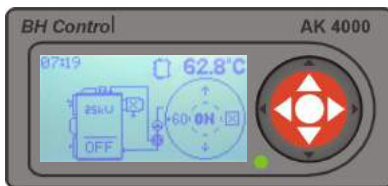

Choose one option	
+60	To start discharge fan for 60 s (use with flame up phase)
ON	Switch on
<input checked="" type="checkbox"/>	Cancel display driver
▲ =	Change indicated figure

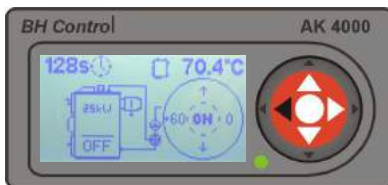

Select „+60“ new graphic drive will appear. Running time of discharge fan is located in the left upper corner of the display.	
+60	You can add extra 60 s - maximum 300 s
ON	Switch on
0	Discharge fan switched-off
▲ =	Change indicated figure

5.1.2 Boiler active – heating phase

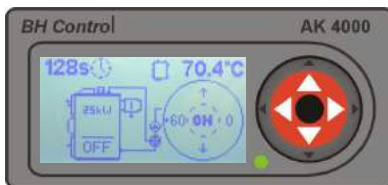

By pressing „ON“ discharge fan will be switched-off and boiler will go to flame-up phase. In flame up phase boiler exhaust gas temperature is lower then set up minimum exhaust gas temperature. Minimum and maximum temperature can be modified in boiler parameters set up. Minimum standard exhaust gas temperature is set up to 50 °C and maximum set up temperature is at 220 °C. The pump works in **pulsating** wave during flame-up, depending on the boiler water temperature.



5.1.3 Boiler active – burning phase

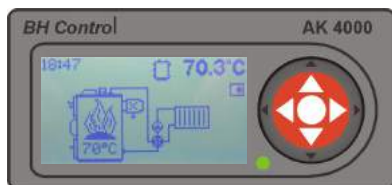

The burning phase is active, when the exhaust gas temperature is (end) +20 °C. The pump is pulsating in this phase. If pump symbol is flashing, pump works. Boiler is responsive to the indoor thermostat, when indoor thermostat is switched off, boiler output is slowly reduced.

5.1.4 Add fuel, boiler switch-off (manual control)

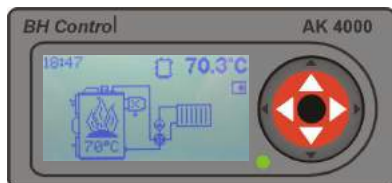

Graphic control is used for this operation. To activate display driver press short middle „ENTER“ button. Graphic control offers option to: switch-off boiler, add fuel or cancel display driver.

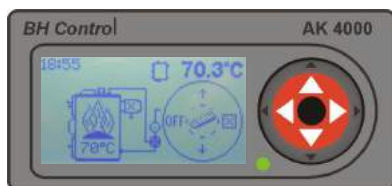

Choose one option	
OFF	Switch off
	Add fuel
<input checked="" type="checkbox"/>	Cancel display driver
	Change indicated figure

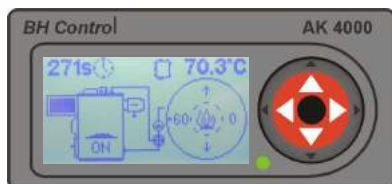
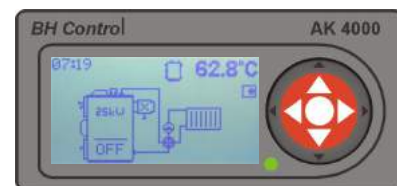

By pressing boiler fan will be switched-off and discharge fan will be switched-on for 300 s. The time is indicated in the upper left corner of the display. By pressing button „+60“ is possible to extend discharge fan running time. Using the rod, open chimney flap, consequently open the upper door. You can add fuel if necessary.

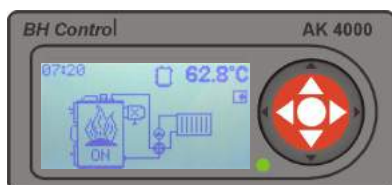

After reloading the fuel close the upper door and chimney flap (pic.12.4). By pressing „0“ discharge fan will be switched off, boiler fan will start working automatically.

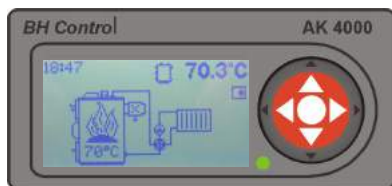

5.1.5 Boiler shut down (automatic)

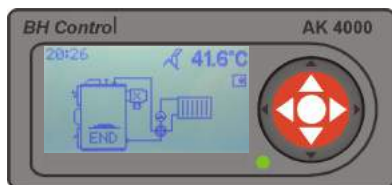

When exhaust gas temperature drops under the set up temperature (end), the boiler is automatically switched-off. Sign „END“ will be indicated on the display. By pressing 2 times button „ENTER“, boiler will start working again.

6. BOILER VIGAS Lambda Control IN BASIC CONFIGURATION

Boiler VIGAS Lambda Control operates with information about oxygen overflow in exhaust gas received from lambda sensor to control the flap of primary and secondary air. This system allows to burn all kinds of wood more efficiently and at the same time decrease the fuel consumption by 20-25 %.

6.1 VIGAS Lambda Control BOILER CONTROL

6.1.1 Boiler activation

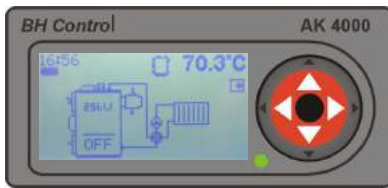

If the boiler is in switched-off phase, with symbol „OFF“ on the display, to retrieve start press short middle „ENTER“ button.

6.1.2 Boiler active – heating phase

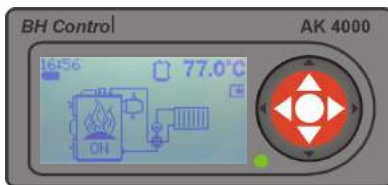

Servo-controlled flap will move to open position (servo 100%) when „ENTER“ button is pressed. Consequently, with next steps (100% up to 45%) flap is moved to retain value of lambda sensor (λ 1,35). In position (servo 45%) secondary air is closed, in position (0 %) primary air is also closed. The flap will move to position 0% only when boiler is „OFF“ or „END“ phase.

In heating phase boiler gas exhaust temperature is lower than set up minimum exhaust gas temperature. Minimum and maximum temperature can be modified in boiler parameters set up. Minimum standard exhaust gas temperature is set up to 50 °C and maximum set up temperature is at 220 °C. The pump works in **pulsating** wave during flame-up, depending on the boiler water temperature.

6.1.3 Boiler active – burning phase



The burning phase is active, when exhaust gas temperature is (end) +20 °C. The servo-controlled flaps work the same as in heating phase. Pump works in **pulsating** wave (boiler safety against low-temperature corrosion). If pump symbol is flashing, pump works.

6.1.4 Add fuel, boiler switch-off (manual control)



Graphic control is used for this operation. To activate display driver press short middle button ENTER. Graphic control offers option: switch-off boiler, add fuel or cancel display driver.

Choose one option	
OFF	Switch off
	Add fuel
<input checked="" type="checkbox"/>	Cancel display driver
	Change indicated figure

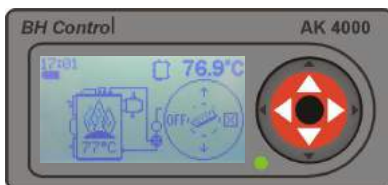
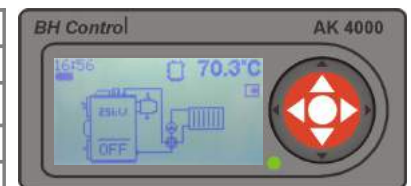

By pressing „“ boiler fan is switched off. Open chimney flap a upper door. Add necessary fuel. After that, close upper door and chimney flap. By pressing „“ finish fuel refilling and fan will be switched on. During fuel refilling, servo-controlled flap retains in the same position, as before fuel adding. When fuel refilling is finished, flap moves to the position (servo 100%). Consequently, with next steps (100% up to 45%) flap is moved to retain value of lambda sensor (λ 1,35). In position (servo 45%) secondary air is closed, in position (0 %) primary air is also closed. The flap will move to position 0% only when boiler is „OFF“ or „END“ phase.

6.1.5. Boiler shut down (automatic)

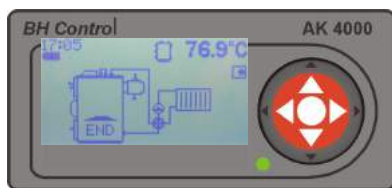

When exhaust gas temperature drops under the set up temperature (end), the boiler is automatically switched-off. Sign „END“ will be indicated on the display. By pressing 2 times button „ENTER“ boiler will start working again.

7. VIGAS Lambda Control BOILER IN CONFIGURATION WITH DISCHARGE FAN

Boiler VIGAS Lambda Control operates with information about oxygen overflow in exhaust gas received from lambda sensor to control the flap of primary and secondary air. This system allows to burn all kinds of wood more efficiently and at the same time decrease the fuel consumption by 20-25 %.

7.1 VIGAS Lambda Control BOILER CONTROL

7.1.1 Boiler activation



If the boiler is in switched-off phase, with symbol „OFF“ on the display, to retrieve start, press short middle button „ENTER“.

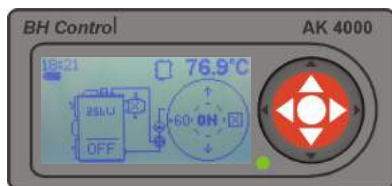

Choose one option	
+60	Start up of discharge fan for 60 s (recommended to use with heating phase)
ON	Switch on
<input checked="" type="checkbox"/>	Cancel display driver
; <	Change indicated figure

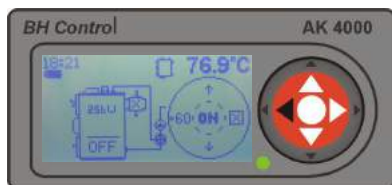

Select „+60“ new graphic drive will appear. Running time of discharge fan is located in the left upper corner of the display.	
+60	You can add extra 60 s - maximum 300 s
ON	Switch on
0	Discharge fan turn-off
▲ =	Change indicated figure

7.1.2 Boiler activated – heating phase

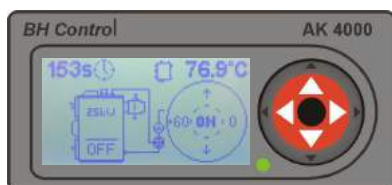

+60 Môžete pridať ďalších 60 s - maximálne do 300 s



By pressing „ON“ button servo-controlled flap will move to open position (servo 100 %). Consequently with next steps (from 100 % up to 45 %) pohybuje tak, aby sa hodnota lambdy udržala blízko nastavenej hodnoty (λ 1,35). In position (servo 45%) secondary air is closed, in position (0 %) primary air is also closed. The flap will move to position 0% only when boiler is „OFF“ or „END“ phase.

In heating phase boiler gas exhaust temperature is lower than set up minimum exhaust gas temperature. Minimum and maximum temperature can be modified in boiler parameters set up. Minimum standard exhaust gas temperature is set up to 50 °C and maximum set up temperature is at 220 °C. The pump works in **pulsating** wave during flame up, depending on the boiler the water temperature.

7.1.3 Boiler activated – burning phase



The burning phase is active, when the exhaust gas temperature is (end) +20 °C. The servo-controlled flaps works same as in heating phase. Pump works on **pulsating** wave (boiler safety against low-temperature corrosion). If pump symbol is flashing, pump works.

7.1.4 Add fuel, boiler switch-off (manual control)

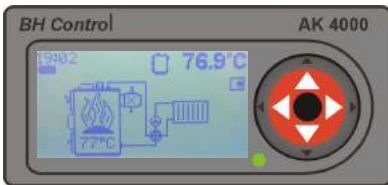

Graphic control is used for this operation. To activate display driver press short middle button ENTER. Graphic control offers option: switch-off boiler, add fuel or cancel display driver.

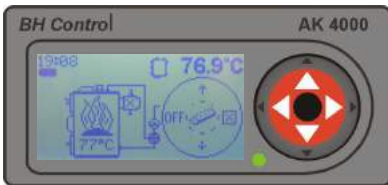

Choose one option	
OFF	Switch off
	Add fuel
<input checked="" type="checkbox"/>	Cancel display driver
	Change indicated figure

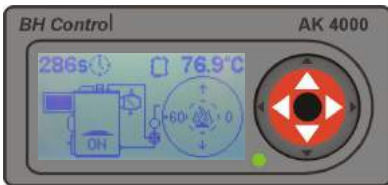
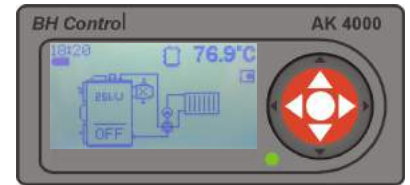

By pressing „“ boiler fan will be switched-off and discharge fan will be switched-on for 300 s. The time is indicated in the upper left corner of the display. By pressing button „+60“ is possible to extend discharge fan running time. Using the rod open chimney flap, consequently open the upper door. You can add fuel if necessary.

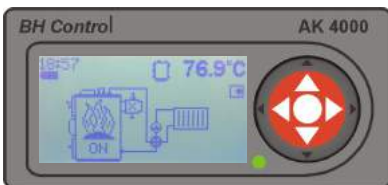

When finished with fuel refilling, close the upper door and chimney flap. By pressing „0“ discharge fan will be switched off. By pressing „0“ discharge fan will be switched off. By pressing „“ fuel refilling is finished, automatically discharge fan is switched off and boiler fan is switched on. During fuel refilling servo-controlled flap retains in position, as before fuel refill. After fuel refilling is finished, the flap moves to position (servo 100%). Consequently, with next steps (100% up to 45%) flap is moved to retain value of lambda sensor (λ 1,35). In position (servo 45%) secondary air is closed, in position (0 %) primary air is also closed. The flap will move to position 0% only when boiler is „OFF“ or „END“ phase.



7.1.5.Boiler shut down (automatic)

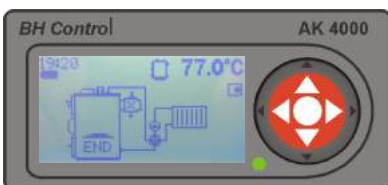

When exhaust gas temperature drops under the set temperature (end) boiler is switched off automatically. Symbol „END“ will appear on the display. Servo-controlled flap will move to position (servo 0 %). In this position primary and secondary air are closed. By pressing 2 times „ENTER“ button, the boiler will start working again.

8. TEMPERATURE SET UP

By pressing „ENTER“ button for 2 seconds temperature set up can be change in any phase of the boiler. In the basic configuration of the boiler (without EXPANDER AK4000), it is only possible to set up heating temperature. Temperature scale is between 70 °C up to 85 °C.

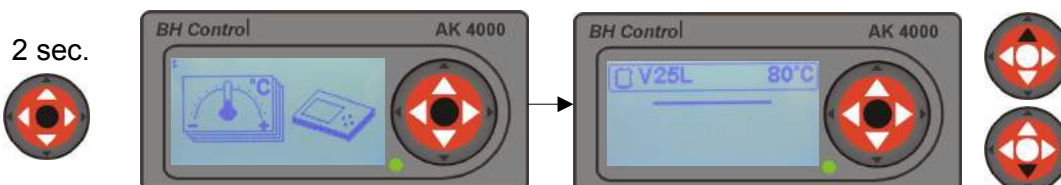

9. PARAMETERS SET UP

By pressing „ENTER“ button for 2 seconds parameters set up can be change in any boiler operating phase and by pressing ▲ button. Parameters set up depends on the type of boiler and configuration.

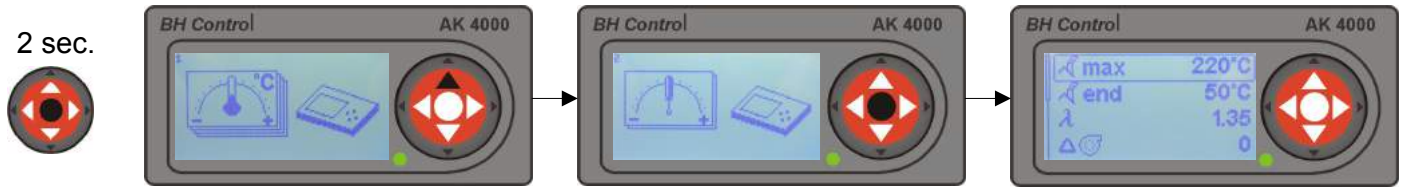

By pressing ▲ =choose parameter to change and by pressing „ENTER“ figure starts flashing. By pressing ▲ =choose required parameter and confirm by pressing „ENTER“.

9.1 MAXIMUM EXHAUST GAS TEMPERATURE SET UP

		<p>max</p>	<p>Select maximum exhaust gas temperature, which will result in decreasing fan speed. It is possible to set up temperature in between 130°C up to 320°C. Temperature set up depends on quality of fuel and chimney draught. Recommended value is 220°C.</p>
--	--	------------	---

9.2 EXHAUST GAS TEMPERATURE SET OFF

		<p>end</p>	<p>Select exhaust temperature which results in automatic boiler switch off and pump shut down. It is possible to set up temperature in between 20 °C up to 130 °C. By selected temperature it is possible to control the size of fire base for next heating phase. Recommended value is 50°C.</p>
--	--	------------	---

9.3 LAMBDA VALUE SET UP

		<p>λ</p>	<p>Lambda value specifies oxygen surplus in exhaust gas. Recommended value is 1.35, which is about 6% of O₂. It is possible to set up this value from 1,2 up to 1,5. By increasing value of O₂ in the exhaust gas, the boiler efficiency will decrease, as well as, emissions.</p>
--	--	----------	--

9.3 FAN OUTPUT SET UP

		<p>min</p>	<p>By increasing or decreasing the value can be changed nominal boiler output. It is possible to change the value from -3 to +3. One degree represents about 10% of boiler output. During low heating season it is advised to decrease this value.</p>
--	--	------------	--

9.4 FAN MINIMUM OUTPUT SET UP

		<p>min</p>	<p>Increasing will change value of minimum fan speed. Value can be selected between 0% up to 70%. After reaching set up value fan will be switched off.</p>
--	--	------------	---

9.5 DISPLAY INTENSITY SET UP

		<p>min</p>	<p>Choose value of display intensity. Select value between 0 up to 100.</p>
--	--	------------	---

9.6 DISPLAY CONTRAST SET UP



Choose value of display contrast. Select value between 18 up to 34.

9.7 SCROLLING MENU SET UP



Roll

By choosing „yes“ line on the display (pic.7) option will show actual boiler values, for example : fan speed, boiler temperature, exhaust gas temperature, etc. By choosing „no“ data, option line can be selected with buttons ▲ =

10. TIME SET UP

Set up time and date when boiler is first time plugged in. Time is indicated in the upper left corner of the display. To retrieve parametres setting press longer „ENTER“ at any boiler phase and press ▲ button twice.

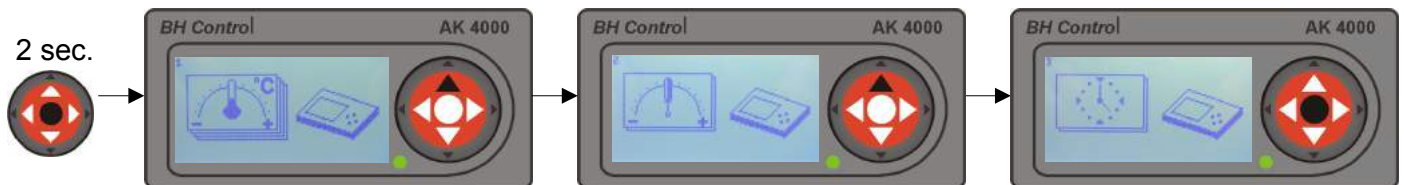

By pressing „ENTER“ button, values start flashing. Pressing ▲ =choose correct time and date. Mon – Moday, Tue – Tuesday, Wed – Wednesday, Thu – Thursday, Fri – Friday, Sat – Saturday, Sun – Sunday.

Warning : Due to electricity power cut clock will stop.

11. HARDWARE AND SOFTWARE INFORMATION

To retrieve information setting hold „ENTER“ button at any boiler phase and press button = Confirm by pressing „ENTER“. Use buttons ▲ =to choose modul and confirm by „ENTER“. Information about modul will be indicated on the display. AK4000D – Display, AK4000S – Power board unit, AK4000L – Lambda board modul.

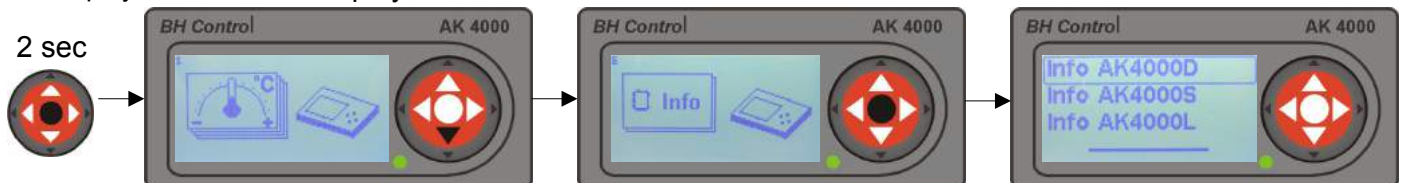

12. ERROR NOTIFICATIONS

To recall error notification hold „ENTER“ button at any boiler phase and by pressing =button twice. By pressing „ENTER“, error with description will be indicated on the display.

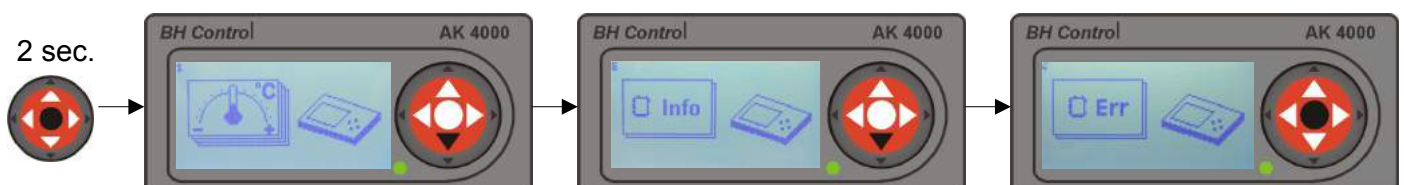

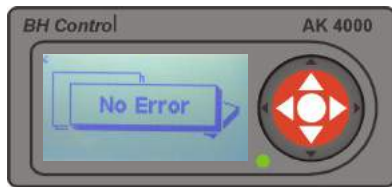

No error condition: Green LED indicator
 Error : Red LED indicator
Error notifications and solutions are described in chapter 18.“
PROBLEMS, CAUSE AND SOLUTIONS“

12.1 STB failure



„STB“ failure is caused by overheating the boiler. Thermal fuse is activated (see pic.). The fan is disconnected from power supply. Boiler is again activated only if „STB“ is reset manually, when boiler temperature is under 60 °C. To switch on the boiler press „ENTER“ button, again.



13. SERVICE SETTINGS PIN 0000 PROTECTED

Service settings under password - **PIN 0000** can be used only in unavoidable cases. Only trained service engineer can do the setting (can be done by customer on special occasion). In service settings can be selected boiler type with accessories and hydraulic connection scheme, etc. To retrieve the service setting under the password „PIN 0000“ press hold „ENTER“ button at boiler phase, press ▲ button and hold button ◀ for 4 s. „PIN 0000“ will appear. Press „ENTER“ button 4 times. Service setting symbol will appear on the display. Press „ENTER“ and by choosing buttons ▲ =select service operation.

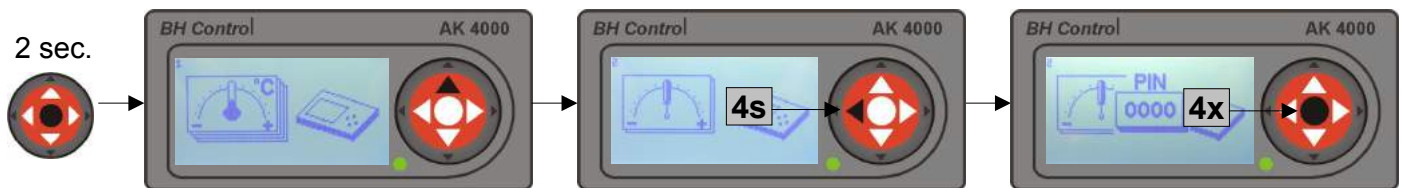

13.1 SERVICE SETTINGS



ATTENTION!

Control display unit of the boiler AK4000 is used to operate all types of VIGAS boilers. It is important that display figure is same as boiler type. When boiler in „OFF“ regime the display shows type of boiler, which is compliant with its nominal output. **For correct boiler operation type of the boiler must be always the same as type indicated on the production sticker label. Always check, in case the display AK4000 is replaced!!!**

13.1.1 Boiler type setting



Choose boiler type. Type of the boiler must be identical with boiler type indicated on the production sticker label. Marking: V25 - boiler output TVZ – hotair boiler, UD – wood-coal, DP – wood-pellets, L – Lambda control.

13.1.2 Lambda sensor setting



It is possible to deactivate lambda sensor from operation if error occurs. In such case it is possible to run boiler in standard version until lambda sensor is replaced.

yes – boiler with lambda sensor, **no** – boiler without lambda sensor

13.1.3 Exhaust gas thermometer settings

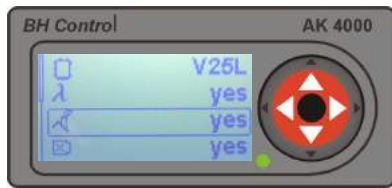

In case of exhaust gas thermometer error it is possible to disconnect thermometer from operation. It is possible to operate boiler until replaced as a standard model. Exhaust gas thermometer will not be used. To deactivated boiler use boiler thermometer, **yes** – boiler with thermometer, **no** – boiler without thermometer.

13.1.4 Discharge fan settings



Discharge fan is an accessory that can be used with boiler. After connecting to the boiler and into the control AK4000, it is necessary to choose option „yes“. **yes** – boiler with discharge fan, **no** – boiler without discharge fan.

13.1.4 Maximum chimney temperature settings



Maximum chimney temperature setting can be selected between 75 °C up to 90 °C. Highest value is used for boiler setting with accumulator tank.

13.1.5 Frequency power supply set up



Frequency power supply setting. It is 50 Hz for EU residents and 60 Hz for USA and Canada residents. If you are not aware of power supply frequency choose AUTO. Incorrect frequency can cause clock error.

13.1.6 Temperature unit setting



Temperature unit set up. Allows to select °C or F - Fahrenheit.

13.1.7 Summer time setting



Allows to set up automatic change of clock to summer time.





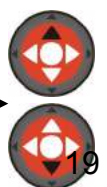
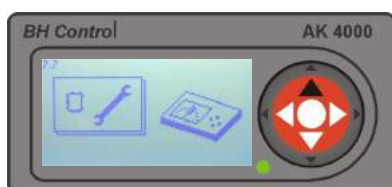





13.2 MODUL AK 4000M SETTINGS

In necessary cases it is possible to connect AK4000 control to modul AK4000M (pic.8). This modul allows to provide upgrades and back-up data maintenance of the boiler control unit. Modul is equipped with data - in line with possibility to connect to BH BUS power board.





obr.8

 → 	To load new configuration (connection schema). Mainly used for systems controlled by EXPANDER AK4000E, where it is possible to load personal connection schema.
 ← 	Actual configuration back-up. It is used for boiler monitoring. It is advised to perform before monitoring.
 → 	To load firmware (boiler operating software).
 Erase	To delete information from modul AK4000M.
 →  mon	Boiler monitoring, to file basic information of the boiler into memory modul.
 → AK4000S	To load firmware in to the power board AK4000S.
 → AK4000L	To load firmware into the lambda power board AK4000.

13.3 FUNCTION SERVICE CONTROL

In service settings can be checked function of each boiler components according to the symbols indicated on the display. By selecting component and pressing „ENTER“ button function will be activated. Displayed components depend on the boiler configuration.

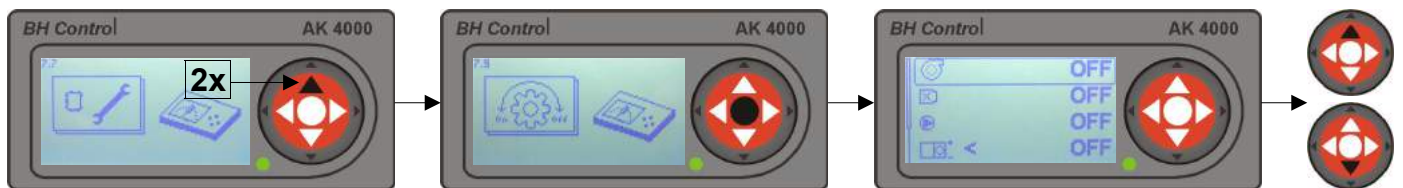

13.4 HYDRAULIC SCHEME BOILER SETTING

By changing hydraulic scheme connection will be changed also control of pump output and boiler configuration. Therefore, it is very important that software setting of hydraulic scheme is identical with existing boiler installation in central heating system. In the basic memory of control unit are 4 basic schemas and schemas intended for operating with Expander AK4000E. On demand, it is possible to add Expander schemas via AK4000M modul (pic.8). Updated schemas for Expander AK4000E can be found on www.vigas.eu

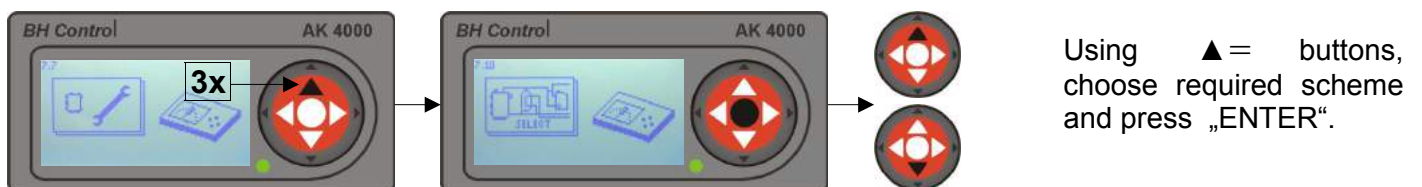

Using ▲ = buttons, choose required scheme and press „ENTER“.

13.4.1 BASIC CONNECTION SCHEMES



Schema 1 is designed for boiler with accumulators tank. „LADOMAT“ provides reverse water protection. Pump is connected to the boiler control and works continuously at temperature over 40°. Requested temperature is possible to set up to 85° (chap.13.1.4). T3 input on power board AK4000S is used to connect thermometer KTY to measure temperature in accumulator.

Attention: Schema 1 does not allow to connect T3 – indoor thermostat!



Schema 2 is designed for central heating systems, where reverse water protection provides external control system. Pump is connected to the boiler control unit and works in pulsating wave depending on the boiler water temperature. T3 contact on power board AK4000S is used to connect indoor thermostat.



Schema 3 is designed with 3-way thermostatic valve (recommended temperature 60 °C) Pump works continuously at temperature over 40 °C. T3 contact on the power board AK4000S is used to connect indoor thermostat.



Schema 4 is designed with 4-way valve controlled manually. Pump works in pulsating wave depending on the boiler water temperature. T3 contact on the power board AK4000S is used to connect indoor thermostat.

13.4.2 CONNECTION SCHEMAS WITH EXPANDER AK4000E

Expander AK4000E complements boiler control unit AK4000. It opens the possibility to control system unit circuits of central heating including regulation of supply water temperature with use of different heating source. Use of indoor thermostat, equithermic control (based on external temperature) or its combination offers to control central heating. Expander AK4000E is supplied in sets. According to particular schema connection, it is supplied as, basic set (order no. 5001), double set (order no. 5002) and triple set (order no. 5003). After verification of connection schemas of Expander, service settings will be supplied with unit settings for central heating system and hot water supply. (Detailed description given in EXPANDER AK4000E service guide).

Technical requirements for additional accessories:

(To specify type, pump diameter and servo-unit consult with professional!)

Pump 230V/50 Hz.

Servo-unit 230V/50 Hz opening period 60 – 240 s

Pump to be installed cca. 0,5 m after 4-way valve.

Maximum electric current for one EXPANDER is 3A.

Additional thermometer to be installed cca. 0,5 m after pump.

External thermometer to be installed on the northern side of building

Indoor thermostat – free of voltage

Expander Basic set (order no. 5001)



Schema 5 with one controlled heating circuit of central heating – floor or radiator heating. Temperature of domestic water according to external temperature, indoor thermostat or combination. Separately controlled boiler pump and central heating pump. Controlled by 4 - way convertor with servo-unit provides boiler safety against low-temperature corrosion. Control: Expander basic set (order no. 5001).



Schema 6 with two separate controlled heating circuits commanded by servo-unit. Possibility to select floor heating, radiator heating or combination. The temperature of domestic water supply according to external temperature, indoor thermostat or combination.

Separately operated pumps of central heating system and boiler pump. Boiler protection against low-temperature corrosion provides 3 - way thermostatic valve (60°C). Control: Expander double set (order no. 5002)



Schema 7 with one controlled heating circuit of central heating with servo-unit for the floor or radiator heating. Heating of hot supply water provides pump. The temperature of domestic water supply according to external temperature, indoor thermostat or combination. Controlled by 4 - way convertor provides boiler protection against low-temperature corrosion. Control: Expander basic set (order no. 5001) + 1x thermometer KTY (order no. 1104).



Schema 8 is designed to control reverse water temperature with 3 - way convertor and boiler pump. The temperature of reverse water is possible to set between 60 °C up to 75 °C. Schema is designed for central heating system, where heating circuit is controlled by external regulation or for the boilers with output over 50 kW (large water flow - over 2,5 m³/hour).

Control: Expander basic set (order no. 5001).

13.5 DISPLAY LINE

Display allows to indicated particular information about control system unit AK4000. By pressing ▲ = choose required data and press „ENTER“. Marked data ☑ will be displayed in information line (chap.3.5).

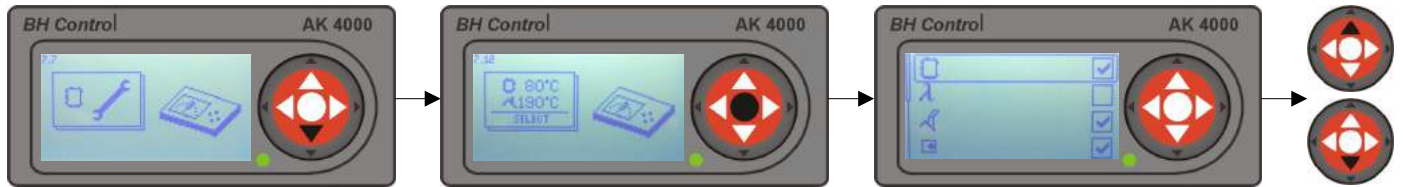

13.6 ELECTRIC CONNECTION - INPUTS AND OUTPUTS OF CONTROL SYSTEM AK4000

Control system AK4000 enables to display each input and output according to actual configuration of the boiler for particular contacts.

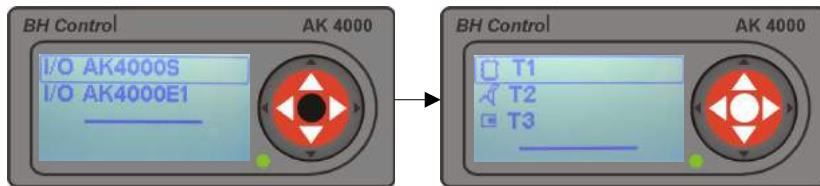

	T1	Boiler thermometer T1
	T2	Exhaust gas thermometer T2
	T3	Indoor thermostat T3

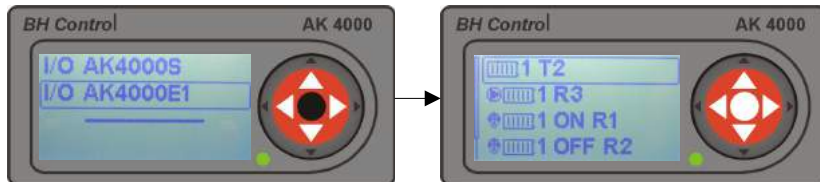

	1 T2	Thermometer UK1 to T2
	1 R3	Pump voltage UK1 to R3
	1 ON R1	Phase servo-unit „OPEN“ to R1
	1 OFF R2	Phase servo-unit „CLOSE“ on R2

14. OPERATING INSTRUCTIONS

14.1 Before operation:

- Be thoroughly informed about operating instructions, manual and electronic control AK4000.
- To check water pressure in central heating system (max. 3 bar).
- To connect electrical components (example:pump, discharge fan, indoor thermostat, etc..)
- To check fireclay bricks support inside combustion chamber (pic.3)
- To check cover metal panels.
- To check power supply connection (230V/50 Hz) ,
- To prepare sufficient amount of fuel for heating and burning phase.

14.2 Boiler in operation

1. Connect boiler to power supply network (230V/50Hz) by connector line.
2. Wait until display is activated to basic image:
 - a) boiler without lambda sensor - immediately
 - b) Boiler with lambda sensor – cca. 30 s (automatic servo-unit initialization).
3. Chap. 4 – 7 choose configuration, that match to your boiler installation with accessories to help handling AK4000 control.
4. Set the boiler AK400 control to deactivated phase **"OFF"**.
5. Fuel heating:
 - a) using rod open chimney (pic.3/3),
 - b) open upper door (pic.3/2) and on fireproof nozzle (pic.3/9) place paper, so that small piece extends to lower burning chamber (pic.3/25), cover with woodchips, then place wood cuts on top and fill-up with solid wood logs,
 - c) close upper door and open slightly lower door (pic.3/13) to achieve fuel heating in the chamber (pic.3/4), if the boiler is equipped with discharge fan use for quick start.
 - d) when fire base is created (approx. after 10 - 15 minutes), closed the lower door and chimney flap using rod,
6. Switch the boiler **„ON“**. Boiler will start combustion and controls its output automatically to required temperature.
7. To refill the fuel follow steps in chap. 4 – 7.
8. To shut down the boiler follow instruction in chap. 4 – 7.

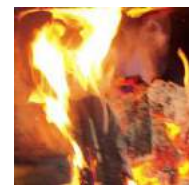

Burning base



Lower door open

14.3 KEEPING OPERATION AND OUTPUT REGULATION

Fuel inside boiler moves spontaneously towards fireproof nozzle. Ash falls through nozzle and deposits in combustion chamber. Boiler output is regulated automatically according to the set up temperature of outlet water. If there is main power cut failure during a longer period of time or if automatic control fails, it is possible to heat as follows (it is only applicable for the systems of central heating with gravitation flow): open chimney flap and let bottom door open a little. If this heating is used, it is necessary to check outlet temperature more frequently and to add less fuel. The boiler may easily become overheated, if chamber is full.

14.4 REFILLING THE CHAMBER WITH FUEL

- ⊕ using rod open chimney flap (pic.3/3),
- ⊕ press „🔥“ button on the display (chap. 4 – 7),
- ⊕ open upper door with caution, to allow the smoke to disappear,
- ⊕ through upper door (pic.3/2) refill necessary volume of fuel,
- ⊕ close upper door (pic.3/2) and chimney flap (pic.3/3),
- ⊕ by pressing „🔥“ button finish fuel refill



Gasifying boiler Vigas

Wood characteristic table

Wood	Fuel efficiency [MJ/kg] 20% humidity	Fuel efficiency [MJ/kg] 25% humidity	Hardness *	weight [kg/m ³] 25% humidity
Poplar	12,9	12,3	1	530
Fir	15,9	14,0	1	575
Spurce	15,3	13,1	1	575
Willow	16,9	12,8	1	665
Pine	18,4	13,6	1	680
Alder	16,7	12,9	2	640
Birch	15	13,5	2	780
Maple	15	13,6	4	660
Beech	15,5	12,5	4	865
Ashen	15,7	12,7	4	865
Locust	16,3	12,7	4	930
Oak	15,9	13,2	4,5	840

[kg/m³] = [kg/fm], fm – fullmeter, * (1 very soft...5 very hard)

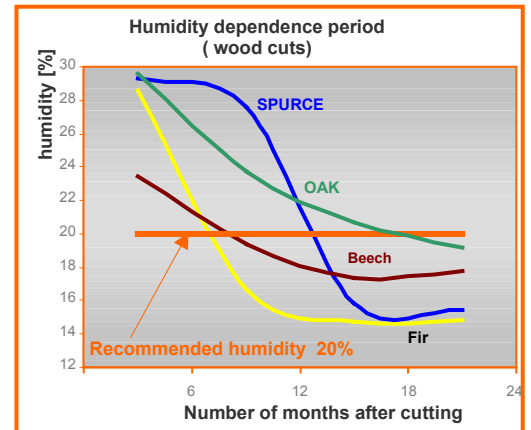

Important attention !!!

- Use only recommended fuel.
- It is advise not to overload the boiler with fuel when in temporary period, boiler tar can be decreased.**
- When adding fuel, do not let it remain between flange and chimney flap, which can cause inaccuarte flap closure.
- It is important to lay fuel properly, so it will not stop upper door to close. Forced closing may damage door concrete inwall.
- We recommend to supervise boiler according to operating conditions only by person over 18 years old.

14.5 SERVICE BOILER CLEANING

During optimal wood burning and keeping minimum temperature of the water reverse at 60 °C is gasifying chamber and exchanger sooted only slightly. By using dampy wood, steam may condense on the walls of the combustion chamber, which creates tar on the surface.

Gasification chamber cleaning

It is necessary to remove tar from gasification chamber once per week. We recommend to burn it with upper door and chimney flap open. If there is extra ash which did not fall through the nozzle (9)pic.3 into fireclay combustion chamber, this should be removed from time to time. Fuel bunker will be increased to original size and primary air flow through nozzle will be increased.



Combustion chamber cleaning

Sweep ash and dust that fell into combustion chamber with a scraper. It is recommended to sweep ash, which settles in combustion chamber once in 3 - 5 days.



Exchanger cleaning

It is necessary to clean exchanger pipes once per month using fire rake (round plate).

Recommendation: If you do not clean exchanger on time and it is clogged with tar, do not use dissolvent. The boiler must be cleaned while hot! Heat boiler through open upper door and chimney flap approx. to 80°C (without fan). Then close flap and door. Carefully (use gloves) open exchanger cover. Clean clogged pipes with relevant accessories. After cleaning, close exchanger cover and let the boiler burn / gasify / approx. 5 hours at maximum performance, in order to get rid of remaining tar. Try to avoid this condition in the future.

Warning: During cleaning must be boiler room very well ventilated!



Step 1.



Step 2.



Step 3.

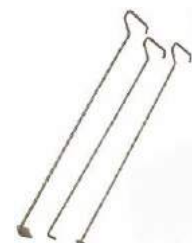

▪ **VIGAS UD29 boiler cleaning**

If using brown coal as fuel, cleaning will be same as wood designed only boiler. Clean fuel bunker with cleaning flap (12) pic.3 and ashtray drawer as follows:

1. Open bottom door (15) pic.3, insert drawer and close the door.
2. Open cleaning flap and upper door (2) pic.5.
3. Use relevant accessory to pile up ash from fuel bunker area into drawer
4. Wait a moment, open bottom door, take out drawer and close the door.

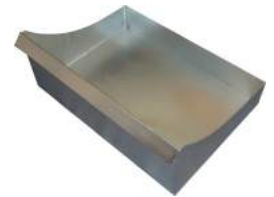

ATTENTION:

Do not leave ashtray drawer inside the boiler VIGAS 29 UD during use.

15. BOILER MAINTENANCE AND REPAIRS

Contractor provides regular checks and boiler maintenance. During operation is important to check water pressure, door seals, chimney flap tightness, exchanger cover and seal, flue way staunchness and fan performance.

WARNING :

Before boiler is shut down for summer season, clean combustion chamber properly, do not leave any condensed moisture inside and open bottom door and chimney flap.

15.1 DOOR SEAL

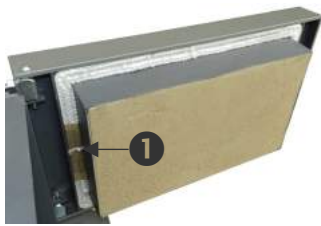

The boiler door are stabilized in 3 points – two rotary pins and door catch. If door does not fit tightly, it is also possible to fix it from hinge side. Slightly turn hinge to release and turn by hinge screw and then move door in desired direction. To change gasket, spot „1“ points out the place, where gasket is connected.

15.2 CHIMNEY FLAP TIGHTNESS

When cleaning exchanger pipes (pic.3/24) make sure that flap area is clean, as well as flap itself. (pic.3/16). Leakage can decrease boiler performance.

15.3 Heatproof nozzle



Heatproof nozzle is block made of heatproof concrete used to mix gases with secondary air and so efficient burning is in progress. Nozzle is located on water cooling rack. Nozzle is surrounded with heatproof concrete in the same height as nozzle. Nozzle lifetime, depends on mechanical damage during fuel adding or poke the fire. Therefore, the nozzle is considered as spare part. Cracks on nozzle are not reason to nozzle exchange, this is necessary only when nozzle drops. If the nozzle is damaged, its necessary to remove bits and pieces of old nozzle and then insert new nozzle into the hole. Check if new nozzle fits in the hole.

15.4 FLAP SERVO-UNIT POSITION SET UP FOR BOILER VIGAS Lambda Control

Correct position of servo-unit and flap to control primary and secondary air are most important condition of burning process with minimum emissions. To position servo-unit and flap do as follows:

- Step 1:** unplug line connector from power supply 230V/50Hz,
- Step 2:** loose screw „1“ with forked spanner,
- Step 3:** using spanner turn axle „2“ to maximum position anti-clockwise, must turn easily!!! In the see-through „3“ window check flap motion.
- Step 4:** tighten screw „1“
- Step 5:** plug connector line to power supply 230V/50Hz.

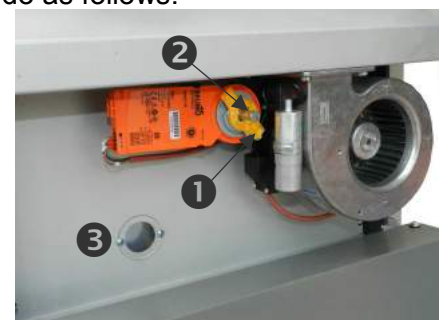

Gasifying boiler Vigas

When line connector plugged in, the power supply servo-unit will start automatic initialization, which is also shown on the display. During this initialization servo-unit is pushed.

15.5 SECONDARY AIR FLAPS POSITION SET UP

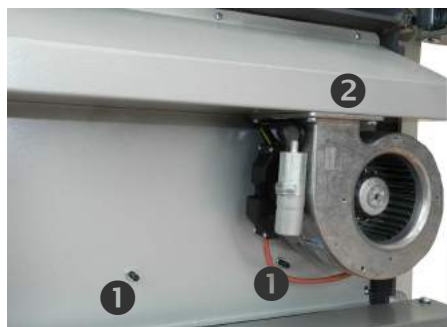

The position of secondary air flaps can considerably affect quality of burning. VIGAS Lambda Control boilers control amount of secondary air automatically. This option provides optimum conditions for burning of all wood types. In VIGAS boilers without lambda sensor is the mixture of primary and secondary air firmly adjusted by screws „1“. Optimum adjustment of secondary air screws „1“ is 2,5 turn from manufacturer. To change or control position do as follows:

- Step 1:** loose safety bolt nut on the screw „1“,
- Step 2:** drive screw „1“ in towards boiler all the way,
- Step 3:** then, adjust by 2,5 turn (optimum),
- Step 4:** tighten safety bolt nut.

TURN	FUEL
0	Not recommended
1	Wet wood
1,5	Wet softwood
2	Dry softwood
2,5	Dry hardwood
2,5 and more	Very dryn hardwood, small chips

Boilers without lambda sensor are equipped with safety flap (above fan) „2“ which stops burning of the boiler without fan (only chimney draught). In case, boiler does not have sufficient output, check this flap function.

15.6 LAMBDA SENSOR AND EXHAUST GAS THERMOMETER

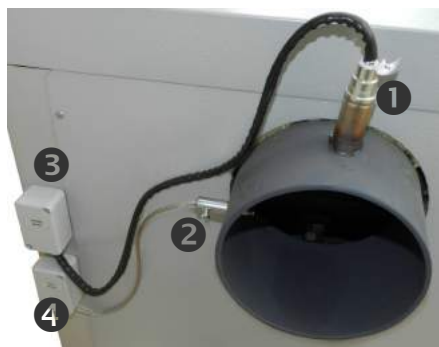

Lambda sensor and exhaust gas thermometer must be clean to function properly. When cleaning exchanger always gently wipe out dust from lambda sensor „1“ and exhaust gas thermometer „2“.

Important: Thermometer must be in accurate position. Its metal insert must be same level as its bipod sleeve. (By changing position of thermometer the temperature will considerably change.) Connect lambda sensor and exhaust gas thermometer to „3“ a „4“ box.

15.7 SECONDARY AIR SYSTEM CLEANING

Clean ways of air pipe system is the basic condition to achieve correct boiler burning process. If often used sawdust as fuel, must be cleaned minimum one time in the season. The system is built form primary and secondary air trunks. The boiler construction allows with advanced parts disassembly offer areas to clean. When fan cover removed (8) pic.3 access to fan is free.

To clean air pipe system do as follows:

Step 1.



Step 2.



Step 3.



Step 4.



Step 5.

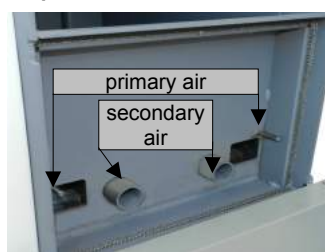

Secondary air cleaning

Attention!!! During cleaning disconnect the boiler from power supply!

- Step 1:** Unplug fan and flap servo-unit connectors
- Step 2:** Under the fan plate disassembly (see chap 15.4 for assembly)
- Step 3:** Use vacuum to Hoover secondary air pipes and check cleanliness.

Step 6./a

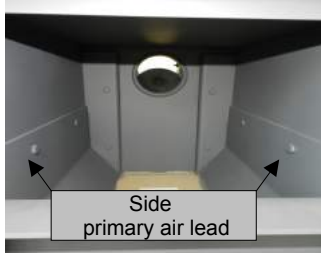

Step 6./b



Primary air cleaning

Please check and clean primary air pipes only, if necessary. Congestion can appear when using wet wood or boiler runs in long term - low performance. Type of primary air design is different for each boiler model.

Step 4: Dismantle primary air separatory panel.

Step 5: Use vacuum and scraper to clean primary leads and check cleanliness.

Step 6: Only in special cases is possible to dismantle vertical primary air lead. With boilers VIGAS 16, VIGAS 25 a VIGAS 40 side primary air lead, also (step 6/a, step 6/b).

Note: It is necessary to use silicone heatproof seal, when this action is repeated.

16. ACCESSORIES AND ASSEMBLY.

16.1 SAFETY DRAIN VALVE

Cooling safety exchanger use:

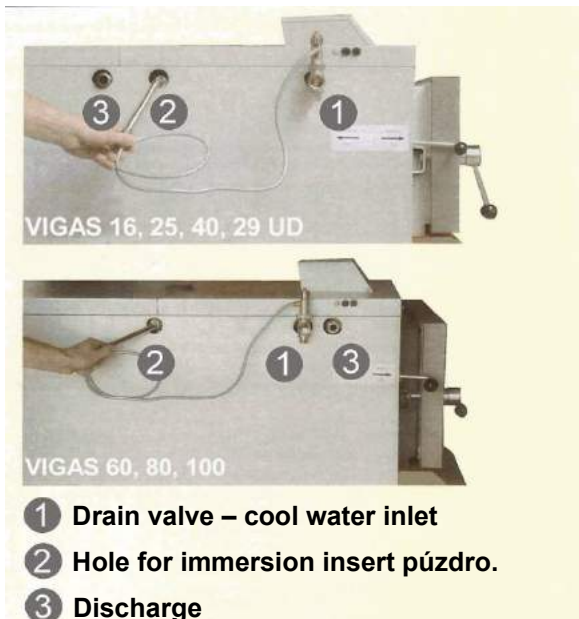

Cooling safety exchanger with drain valve TS 131 provides boiler protection against overheating due to power cut. By forced circulation the pump and water flow in the central heating will shut down. If you do not have option of automatic gravity convection or minimum heat consumption of 5 kW, boiler may be overheated. Drain valve TS 131 and cooling exchanger will restrain boiler for overheating.

Assembly of drain valve TS 131:

Drain valve TS 131 screw in the boiler socket „1“ so it may close water prior to boiler inlet. Safety exchanger must be water free. Second socket „3“ pic., must be directed to drainage. Thermal sensor insert into ½“socket, pic. „2“.

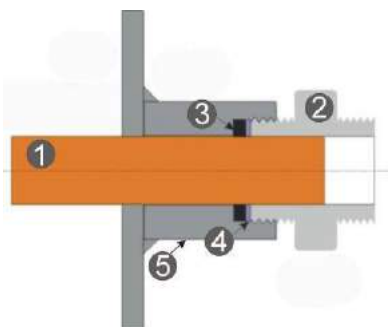

Warning:

- Valve and thermal sensor assembly is necessary before central heating system is filled with water.
- The pressure of cooling water can not subordinate to power supply.
- It is adviced not loose ¾“ socket „2“ pic. Water leak can appear. There is an aluminium ring „4“ under the insert „3“ to seal copper pipe „5“. If water leaks, tighten ¾“ insert „2“.

Operation rule:

Drain valve is regulated by hot water. If water temperature is 95 °C, valve opens. Water running from main distributing source will absorb the temperature from boiler and prevent it from possible damage and overheating. This boiler protection system complies with standards STN EN 303-5.

16.2 DISCHARGE FAN

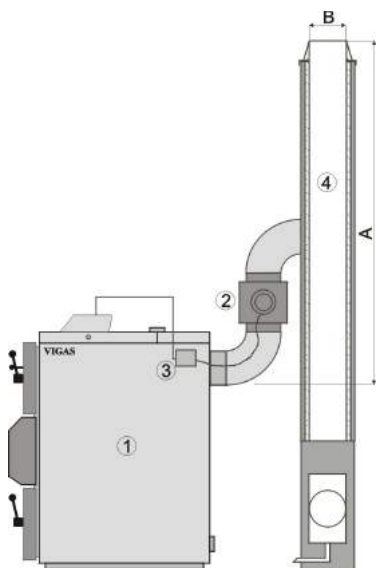

Discharge fan „2“ is designed to eliminate exhaust gas in the boiler area during fuel refill. In case boiler chimney does not comply with minimum parametres „A“ a „B“, it’s recomended to install discharge fan, too. Shall be installed between chimney flue and chimney body. Condenser „3“ should be attached on the side of the boiler. It is connected to power board unit AK 4000S. Possible to order in two different sizes.

V25 (order no. 0507) – for VIGAS 16,18DP, 25, 29 UD.

V80 (order no. 0508) – for VIGAS 40, 60, 80, 100.

Boiler type	Min A	Min B
VIGAS 16, VIGAS 18 DP VIGAS 25, VIGAS 29 UD	8 m	160 mm
VIGAS 40	8 m	200 mm
VIGAS 60, VIGAS 80, VIGAS 100	12 m	200 mm

Drawing of parametres V25 and V80 at - www.vigas.eu



16.3 CIRCULATION PUMP AND 3 - WAY THERMOSTATIC VALVE



Electric control allows to connect pump on the power board unit AK4000S without using expander, even in basic version. Pupm operation depends on the selected hydraulic scheme and boiler temperature. Pump works in pulsating cycle or persistent cycle.

Pulsating cycle allows pump to go „ON“ or „OFF“ in certain period of time. The activity ratio depends on the boiler output temperature. The advantage of this cycle is boiler protection against low-temperature corosion.

Persistant cycle si used only with 3 - way thermostatic valve or Ladomat installation. See chap. 13.4.1.

When pump in action, indication symbol will be flashing on the display.

16.4 INDOOR THERMOSTAT



By connecting indoor thermostat to the boiler, maintenance will become more comfortable. It is necessary to connect indoor thermostat to power board unit AK4000S. Connect to T3 input contact. Switching contact element is voltage free. If contact T3 is disconnected, the display will show sign „OFF“ for indoor thermostat. The blower fan will shut down. The boiler status is indicated by „“ symbol. When indoor thermostat „ON“ again, boiler is activated.

Warning: If indoor thermostat is disconnected for more the 1 hour, the blower fan will operate in short intervals to keep boiler activated.

17. SERVICE DEPARTMENT

In order to keep quality and safe maintenance, repairs of the boiler must be done by authorized service engineers appointed by manufacturer:

Pavel Vigaš - VIMAR, Príboj 796, Slovenská Ľupča, Slovakia.

tel. 00421 48 41 87 022.

tel. 00421 48 41 87 159

email: vimar@vimar.sk, web: www.vigas.eu

18. PROBLEMS, CAUSE AND SOLUTION

Problem	Cause / Solution
During heating season the boiler output is decreasing to compare with previous heating period.	Used fuel is wet. To clean air pipe system. To clean fan air wings.
When chimney flap closed, boiler is combustion properly for some time, then smoke appears.	Not enough primary air. Clean system of primary air pipes. Check if flap placed behind the blower is functional.
Combustion chamber contains unburned wood.	Nozzle hole enlarged. Change nozzle. Set up secondary air to required position : 3 turns of flap back from closed position. Lower the temperature ↘ end. See chap.9.2.
Smoke leaks through door seal after door closed.	Insufficient door tightness. Adjust the door. Check door tightness. Remove gasket and place other way or replace gasket for the new one.
Trouble to open chimney flap.	Chimney flap is glued by tar. Increase boiler operating temperature. Use dry fuel. Increase temperature ↘ end. See chap. 9.2.
After upper door and chimney flap opened, boiler room beomes smokey.	Low chimney draught. Chimney diametre must be bigger than diameter of boiler flue outlet. Discharge fan recommended. See chap.16.2.
Cracked fireproof/concrete/ filling	It is no defect. Separates combustion chamber from gasification chamber.
Fan does not turn. Starts working when pushed with hand.	Fan condenser is defected . Change condenser.
After heating phase ,the boiler will shut down.	Incorrectly selected „End“ temperature. See chap.9.2. for configuration.
Boiler is shut down, but fan still works.	Damaged wires leading to the fan. Zero leading wire is connected with ground wire
Pump is operating even if symbol  does not show.	Damaged pump wires. Zero leading wire of pump is connected to ground wire.
Warning indications and nifications	Cause/ Solution
T max	Display shows T max if boiler exceeds set up temperature over 8°C.

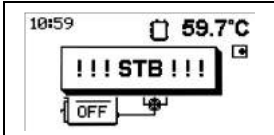
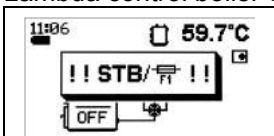
Error notification	Error identification (MENU 4)	Cause/ Solution
<p>STB Error</p>  <p>Red control LED indicating</p>		<input type="checkbox"/> Boiler overheated – when boiler cools down, reset STB fuse manually.
<p>Lambda control boiler STB error</p>  <p>Red control LED indicating</p>		<input type="checkbox"/> Boiler overheated – when boiler cools down, reset STB fuse <input type="checkbox"/> Suspended fuse F1A, control system is conencted from AK4000PS

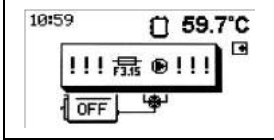

Gasifying boiler Vigas

Suspended fuse 3,15A

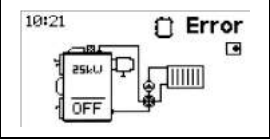
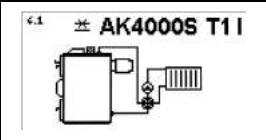
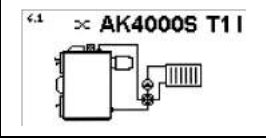
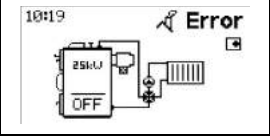
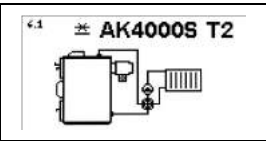

Red control LED indicating

- Suspended fuse 3,15A which joins boiler.
- Check pump connection.

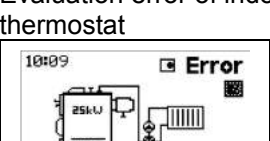
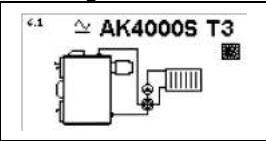
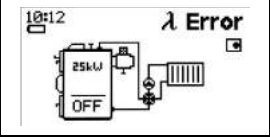
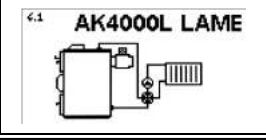
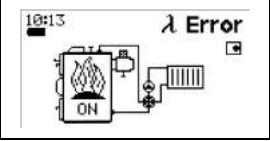
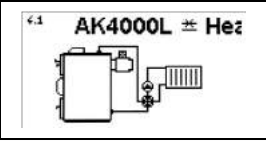
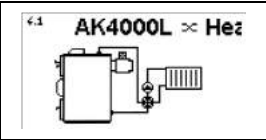
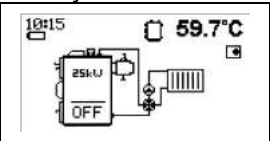
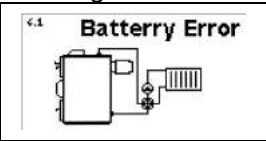
<p>Boiler temperature reading error</p>  <p>Red LED control indicating</p>	<p>Disconnected boiler thermometer AK4000D T1 KTY</p> 	<ul style="list-style-type: none"> <input type="checkbox"/> Disconnected thermometer - check thermometer <input type="checkbox"/> Damaged thermometer - replacement required
	<p>Boiler thermometer in short circuit AK4000D T1 KTY</p> 	<ul style="list-style-type: none"> <input type="checkbox"/> Damaged thermometer – replacement required <input type="checkbox"/> Short circuit in connection place of thermometer - revise
<p>Exhaust gas temperature error</p>  <p>Red LED control indicating</p>	<p>Boiler exhaust gas thermometer disconnected AK4000D T2 KTY</p> 	<ul style="list-style-type: none"> <input type="checkbox"/> Disconnected chimney thermometer – check thermometer <input type="checkbox"/> Damaged chimney thermometer – replacement required.
	<p>Exhaust gas thermometer short circuit AK4000D T2 KTY</p> 	<ul style="list-style-type: none"> <input type="checkbox"/> Damaged chimney thermometer – replacement required <input type="checkbox"/> Short circuit in connection area - revise.
<p>Evaluation error of indoor thermostat</p>  <p>Red LED control indicating</p>	<p>Reading indoor thermostat error</p> 	<ul style="list-style-type: none"> <input type="checkbox"/> Indoor thermostat signal disturbance caused by induction of simultaneous power supply.
<p>Evaluation error of lambda sensor</p>  <p>Red LED control indicating</p>	<p>Communication error of AK4000L LAMBDA COM</p> 	<ul style="list-style-type: none"> <input type="checkbox"/> Damaged AK4000L modul.
<p>Evaluation error of lambda sensor</p>  <p>Red LED control indicating</p>	<p>Disconnected A-supply of lambda sensor</p> 	<ul style="list-style-type: none"> <input type="checkbox"/> Wire disfunction <input type="checkbox"/> Lambda sensor error
	<p>Short circuit of A-supply for lambda sensor</p> 	<ul style="list-style-type: none"> <input type="checkbox"/> Aborted heating LS <input type="checkbox"/> Aborted power line k LS
<p>Battery status</p>  <p>Red LED control indicating</p>	<p>Discharged batteries</p> 	<ul style="list-style-type: none"> <input type="checkbox"/> Replace batteries

19. INSTALLATION INSTRUCTION

Gasifying boiler Vigas

Recommended basic schemas with AK4000 control

Obr.9

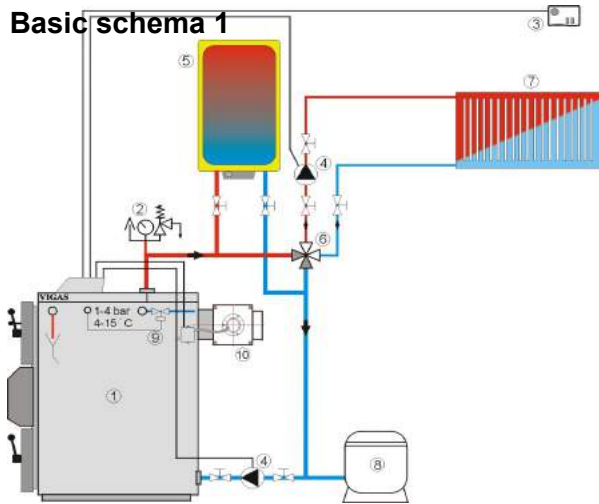

Obr.10

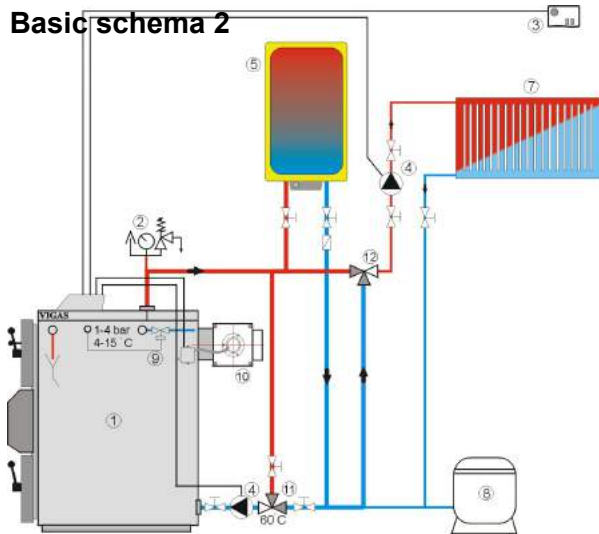
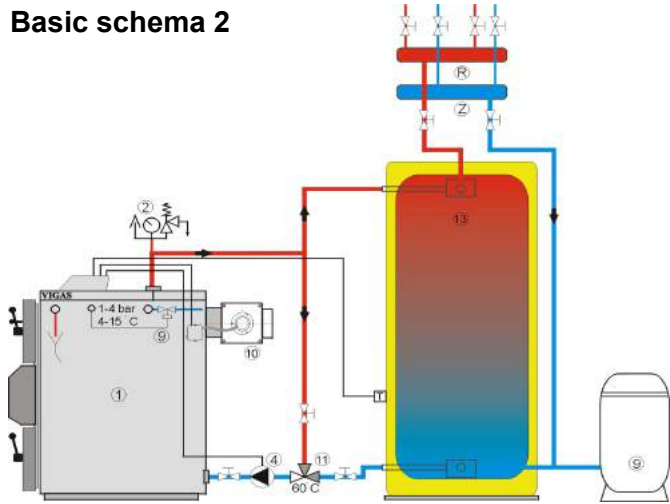

Basic schema 1
Boiler control system AK 4000 regulates simultaneously boiler pump and circulating pump with possibility to connect indoor thermostat to control burning phase or discharge fan in case of low chimney draught occurs. Mixing of water boiler to required temperature for heating circuit provides 4 - way mixing valve and at the same time warms up reverse water for the boiler circuit. When, heated area reaches required temperature pumps go off and boiler will maintain its temperature.

Basic schema 2
Boiler control system AK 4000 regulates simultaneously boiler pump and circulating pump with possibility to connect indoor thermostat to control burning phase or discharge fan in case of low chimney draught. Thermostatic by-pass valve (11) provides reverse water temperature at 60°C. To regulate temperature in central heating circuit manually provides 3 - way mixing valve (12). When heated area reaches required temperature pumps go off and boiler will maintain its temperature.

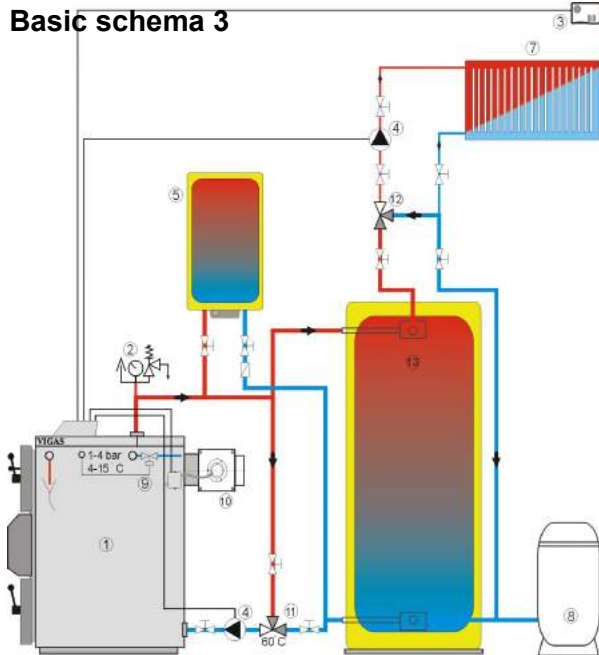

Basic schema 3
Boiler control system AK 4000 regulates simultaneously boiler pump and circulating pump with possibility to connect indoor thermostat to control burning phase or discharge fan in case of low chimney draught. Thermostatic by-pass valve (11) provides reverse water temperature at 60°C. To regulate temperature in central heating circuit manually provides 3 - way mixing valve (12). Lifetime of the boiler can be prolonged by installation of accumulator tank, it will decrease fuel consumption and increase maintenance comfort. When heated area reaches required temperature pumps go off and boiler will maintain its temperature.

Basic schema 4
Boiler control system AK 4000 regulates boiler pump with possibility to connect accumulator thermometer and discharge fan in case of low chimney draught. Thermostatic by-pass valve (11) provides reverse water temperature at 60°C. Lifetime of the boiler can be prolonged by installation of accumulator tank, it will decrease fuel consumption and increase maintenance comfort. Circuits regulation behind device is provided by EXPANDER AK4000E.

19.1 Assembly and installation instruction

1. Boiler Vigas	5. Domestic water tank	9. Drain valve	13. Accumulator tank
2. Safety element	6. 4 - way valve	10. Discharge fan	R – Device
3. Indoor thermostat	7. Central heating circuit	11. Thermostatic by-pass valve ESBE	Z - Collector
4. Pump	8. Expansion tank	12. 3 - way mixing valve	

- Boiler can only be connected to the central heating system with appropriate thermal capacity with boiler output.
- When using forced circulation, central heating system must be adapted in case of power cut to ensure boiler output at 5kw. This is provided with safety cooling exchanger with drain valve TS 131, (Honeywell valve TS131 is not part of delivery component) , can be purchased separately.
- If boiler is installed with accumulator tank, the minimum tank volume is calculated as follows:

$$V_{sp} = 15T_B \times Q_N \cdot 1 - 0,3Q_H/Q_{min}.$$

V_{sp} – volume of accumulator tank	Q_N – nominal heating output	T_B – combustion interval
Q_H – required boiler output for heating area	Q_{min} – minimum heating output	

- Boiler must be connected correctly and as short as possible to chimney. Other appliances must not be connected to chimney. Chimney shaft must be dimensioned according to the standards: STN 734201 and STN 734210.
- We do not recommend permanent connection to water supply through feed water valve to avoid not allowed increase in pressure if valve is not tightly sealed. Maximum overpressure is 0,3 MPa.
- The room where boiler is placed must be ventilated properly.
- Boiler assembly must be done by specialists of installation company
- Boiler must be commissioned by trained technician.
- Boiler does not require to be placed on a firm base.
- Minimum temperature of boiler reverse water on inlet is 60 °C.
- Boiler room must be ventilated permanently through the opening of min. diameter 0,025 m2. The diameter for air inlet and outlet must be approximately equal.
- Boiler must be installed in the surrounding that is usual, basic in accordance with the standard STN 33 2000-3.
- Work and health safety regulations must be followed in accordance with current instruction requirements, UBP SR No. 718/2002 Coll. and seq.
- Required standards SN 73 0823:1983/z1 – The flammability degree of building material must be observed, regarding fire facility surrounding of the boiler.

19.2 SAFETY REGULATIONS FOR CONTROL AND MAINTENANCE OF VIGAS BOILER ELECTRIC EQUIPMENT

The boiler operator must follow relevant regulations and standards, as well as the following principles:

- If boiler is in operation, none of the following may be done with electric equipment:
 - uncover electronic equipment, e.g. boiler electronics, fan, thermostat,
 - to exchange fuse,
 - to repair damaged cable insulation, etc.
- Maintenance and repairs of boiler with uncovered electric equipment may only be done by persons authorized to do so, according to 74/1996 Coll.
- Before uncovering boiler or any electric equipment connected to boiler, it is necessary to disconnect any mains /unplug/. You can only plug in after placing covers on original places.
- If there is any defect of electric equipment or boiler installation is damaged it is important:
 - do not touch any part of boiler
 - disconnect boiler from mains /unplug/ immediately
 - to call an authorized service technician that will correct defect.

Apart from common maintenance of boiler, it is strictly forbidden:

- to manipulate electric equipment and boiler installation if plugged in,
- to touch damaged electric equipment and boiler installation, mainly damage cable insulation, etc.,
- to operate boiler if uncovered,
- to operate boiler with defective electric equipment or defective boiler installation
- to repair damaged boiler electric parts by persons unauthorized by manufacturer

Gasifying boiler Vigas

Electric schema				
No.	Description	Code		
1	AK 4000D Display	4001	•	16,25,40 UD 29 kW
2	AK 4000S Power board	4002	•	60,80,100 kW
2a	AK 4000SL Lambda board	4003	-	-
3	Fan	0514	•	2
3a	Condenser	0515	•	2
4	STB fuse	3029	•	2
5	Thermometer type KTY	3026	•	•
6	Gas sensor type PT 1000	3027	•	•
7	Servo Belimo	3008	-	•
8	Lambda sensor	3009	-	•
9	Supply RS 25 - 12	4004	-	•
10	Accumulator thermometer type KTY (4m)	3032	•	•
11	Discharge fan	0507	•	-
12	Expander AK4000	SET	•	•
13	Memory modul AK4000M	4007	•	•
14	Indoor thermostat	3030	•	•
K1	Connector	3025	•	•
K2	Fan wire	3010	•	•
K3	Wire set for STB fuse	3015	•	•
K4	Thermometer connection modul	3023	•	•
K5	Main ground wire	3018	•	•
K5a	Ground wire for the control cover panel	3019	•	•
K6	Communication wire AK40000 (4P4C 0,4m)	4006	•	•
K7	Lambda sensor connection modul	3024	-	•
K8	Wire for servo-unit	3025	-	•
K9	Wire set for power supply RS 25 - 12	3013	-	•
		4005	-	•

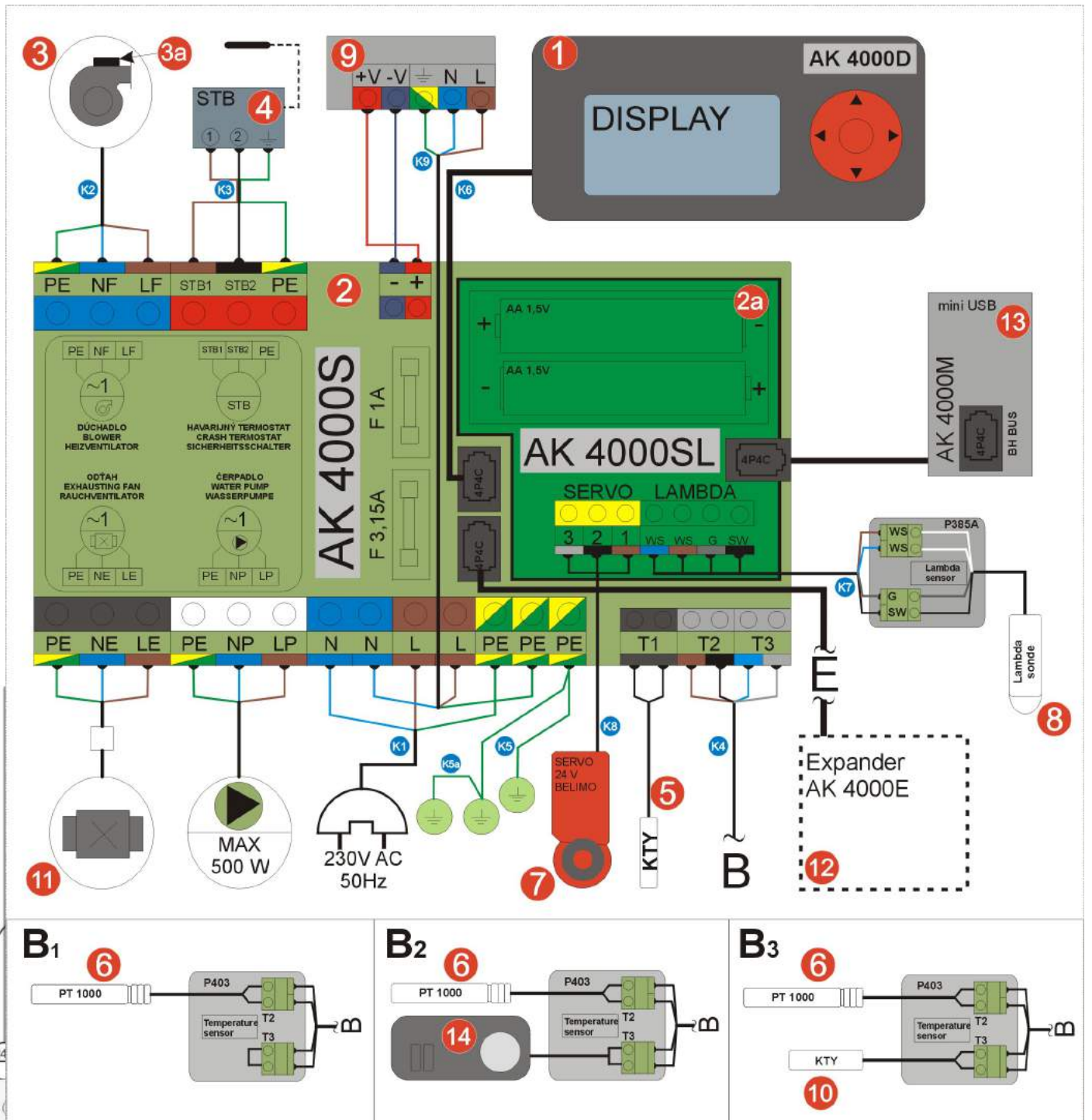

LETTER OF WARRANTY

Certificate of Quality and Completeness

Product

VIGAS

 kW

Serial number :

Producer confirms, that boiler complies with standards, STN EN 303-5:2012, STN EN 61010-1+A2:2000, STN EN 50081-1:1995, STN EN 50082-1:2002, STN EN 61000-3-3:2000, STN EN 61000-3-2:2000+A1+A2:2001.

Production inspection day

.....
Stamp and signature of manufacturer

Date of purchase

Date of commission

.....
Stamp and signature of seller



VIGAS commission certificate

Product

VIGAS

kW

Serial number

Date of purchase

Date of commission

.....
Stamp and signature of dealer

.....
Signature of heating specialist

User name and address :

Instructions for customers and warranty conditions.

- Claims regarding the completeness of delivery must be in accordance with Commercial Code and Civil Code of the supplier.
- Damage and defects due to transport must be claimed by customers to a carrier, when goods is taken over.
- Warranty period is 24 month from the date of sale.
- Warranty is valid if boiler is commissioned by an authorized serviceman.
- Warranty is valid if all the electric equipment is connected to regulation only by trained specialist and recorded in relevant documents..
- Warranty applies to construction, used material and product manufacture.

Warranty does not apply to:

- Consumer material: gaskets, exchanger seal, under fan seal, heatproof nozzle, heatproof filling, fireclay bricks
- Defects caused by customer
- Defects due to incorrect assembly instructions, operation and maintenance or if product is used otherwise than instructed, used for different purpose than specified by producer, unauthorized handling.
- Otherwise, to claim warranty, relevant statutes will apply according to Civil Code.
The producer reserves the right to provide changes within framework of the product innovation.



Following operations were performed during commissioning

- Thoroughly explained maintenance and servise of the boiler to the customer
- Boiler revision before fire
- Burning test in the boiler
- To fill and confirm data in the warranty

Owner of the boiler - signature

Records on electric device connection(pump, discharge fan,indoor thermostat, expander, etc.)

Date	Device	Service person name	Certificate no.	Service person signature

Records on warranty and after warranty repairs

Date	Number of repair protocol	Service person name	Certificate no.	Service person signature

Notes



Serial number



PRODUCER:

Pavel Vigaš - VIMAR
M. Čulena 25
974 11 Banská Bystrica
SLOVAKIA
tel.: 00421 48 4187 022
www.vigas.eu, vimar@vimar.sk

DISTRIBUTOR:



*All technical changes are reserved by VIMAR 2013 ver.1
Pictures are illustrative and might be different from reality!*