



Samsung Electronics

ERV NASA - Integration- (Energy recovery Ventilation)

Contents

- ◆ Introduction
- ◆ Line-up
- ◆ Feature
- ◆ Part analysis
- ◆ How to design
- ◆ How to install
- ◆ Application

SAMSUNG

15552635

Introduction

- **What is ventilation?**
- **How to conduct ventilation**
- **What is ERV**
- **Psychometric chart & efficiency**

SAMSUNG

15552635

Introduction

■ What is ventilation?

Ventilation is the process of supplying and removing air by natural or mechanical means to and from any space.

✓ Necessity of Ventilation

Indoor air quality is gaining more and more attention as increasing numbers of people become ill from airborne contaminants. Indoor air contamination is often the cause behind building-related syndromes, such as asthma, headaches and dizziness.

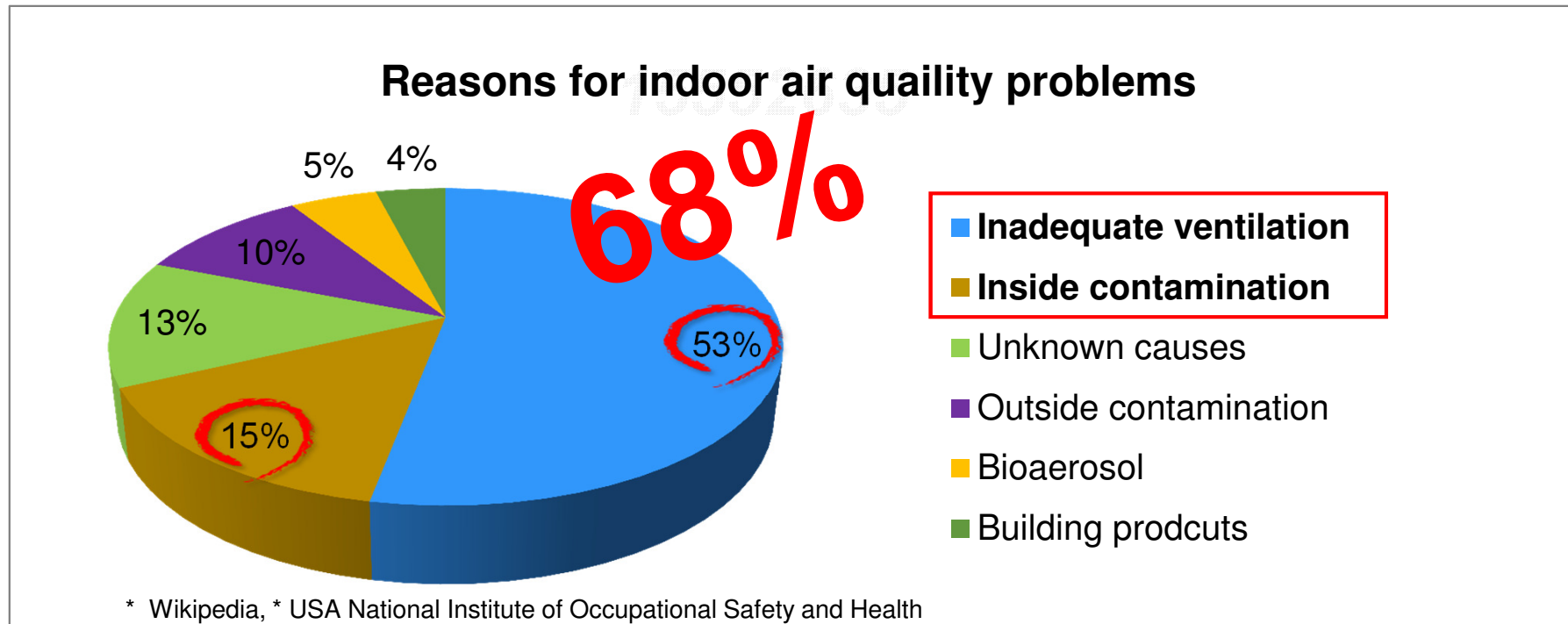

Introduction

■ How to conduct ventilation

✓ 3way to conduct mechanical ventilation

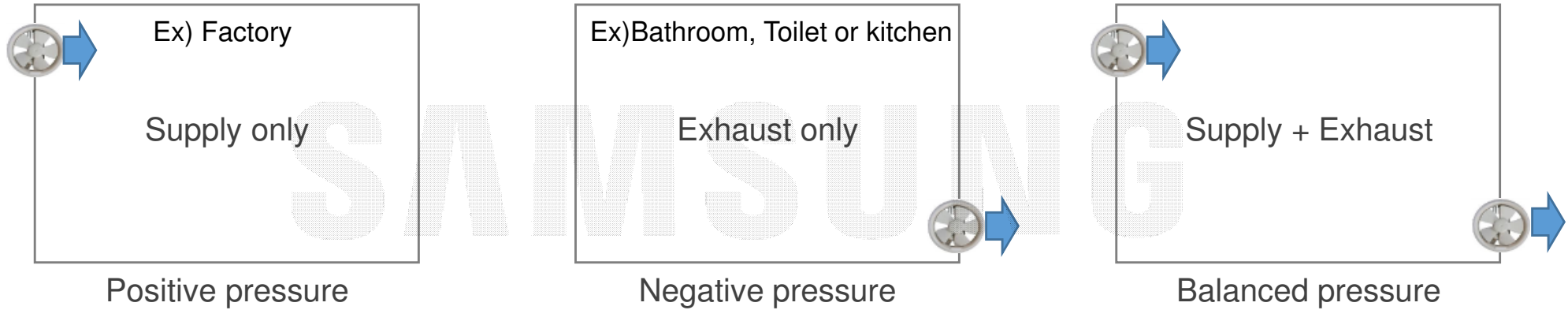

15552635

✓ Units for Ventilation in DVM system

<p>Positive pressure</p> 	<p>Balanced pressure</p>  <p>ERV</p>	<p>Balanced pressure</p>  <p>ERV+</p>	<p>Balanced pressure</p>  <p>AHU</p>
--	--	---	--

Introduction

■ What is ERV

The **Samsung ERV** (Energy Recovery Ventilation) system air conditioner provides fresh and healthy air from outside while **minimizing energy loss for maximum efficiency**. Its intelligent structure incorporates features specifically designed for flawless ventilation and efficient operation.

The system recovers **up to 70 percent** of the energy needed to cool or heat the environment. The efficient heat recovery maintains the indoor temperature and humidity during the winter, and prevents outdoor heat and moisture from entering indoors during the summer.

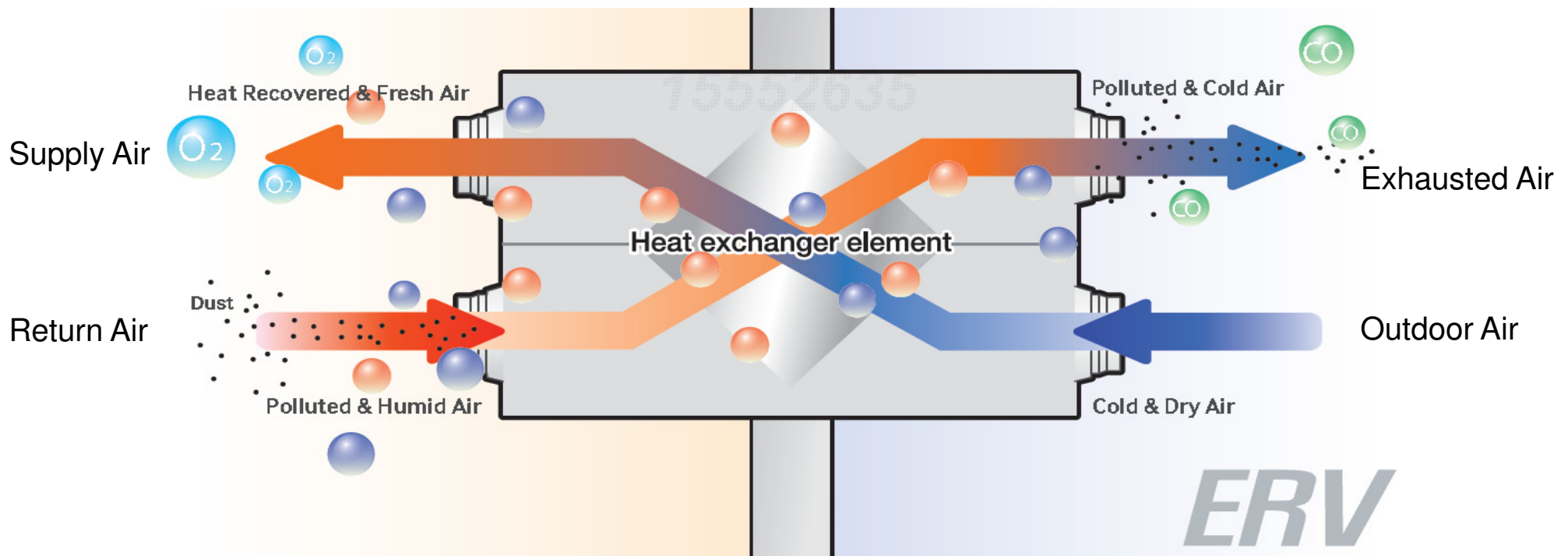

Introduction

■ What is ERV

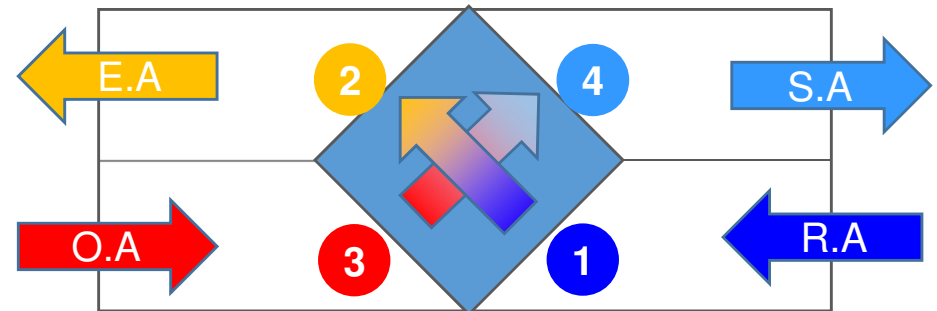
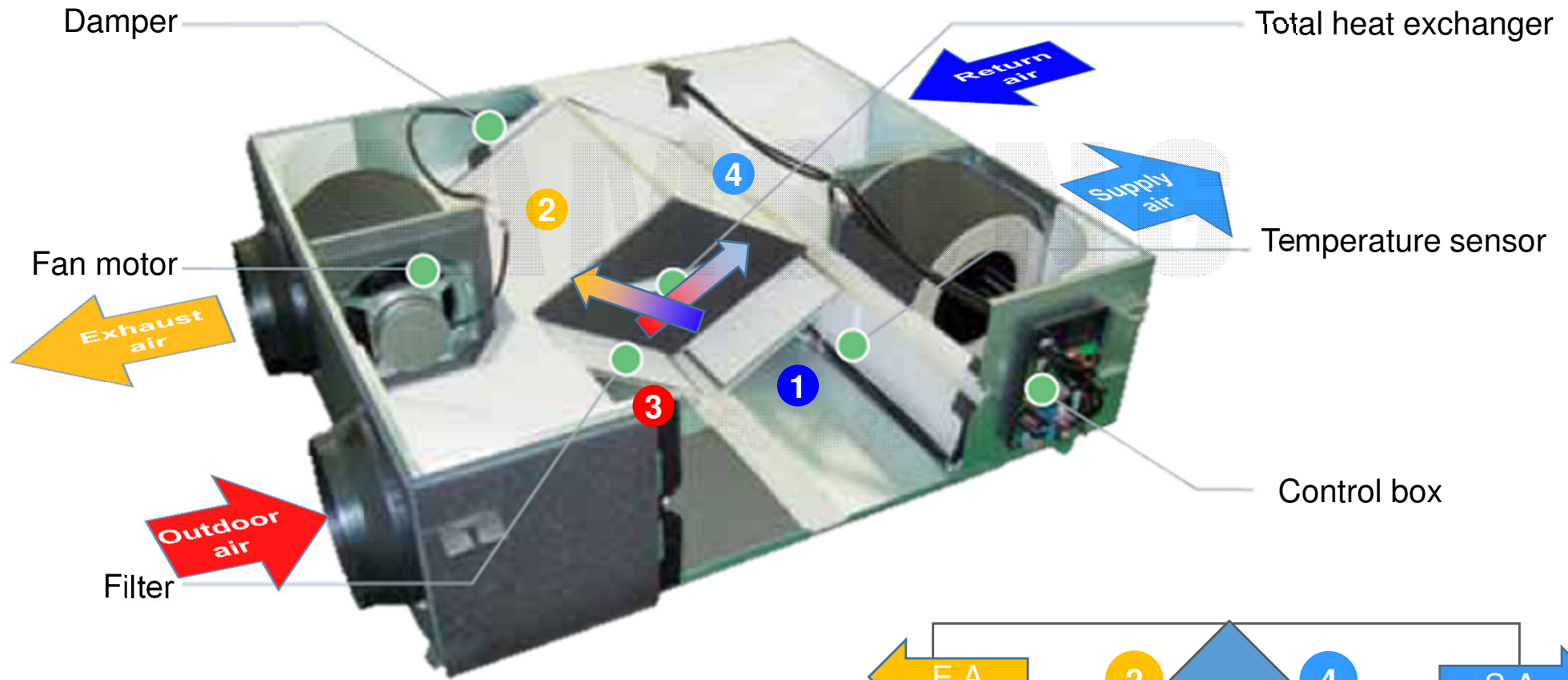

Introduction

■ Psychometric chart & efficiency

Temp : 35°C(DB)
RH : 40%RH
AH : 14.1(g/kg)
Enthalpy : 71.5kJ/kg

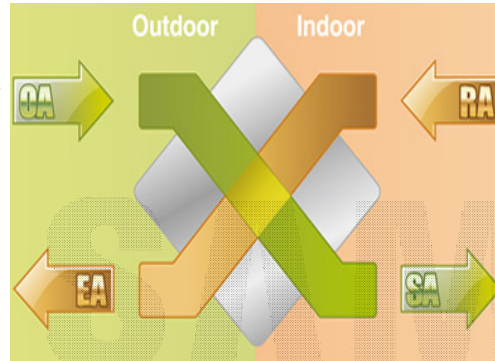

Temp : 24°C(DB)
RH : 50%RH
AH : 9.3(g/kg)
Enthalpy : 47.8kJ/kg

Temp : 27.3°C(DB)
RH : 55.7%RH
AH : 12.6(g/kg)
Enthalpy : 59.6kJ/kg

Temp : 31.7°C(DB)
RH : 37%RH
AH : 10.8(g/kg)
Enthalpy : 59.6kJ/kg

Temperature Efficiency	Enthalpy Efficiency
$= \frac{t(OA) - t(SA)}{t(OA) - t(RA)} \times 100$	$= \frac{h(OA) - h(SA)}{h(OA) - h(RA)} \times 100$
$\frac{(35.0 - 27.3)}{(35.0 - 24.0)} = 70\%$	$\frac{(71.5 - 59.6)}{(71.5 - 47.8)} = 50\%$

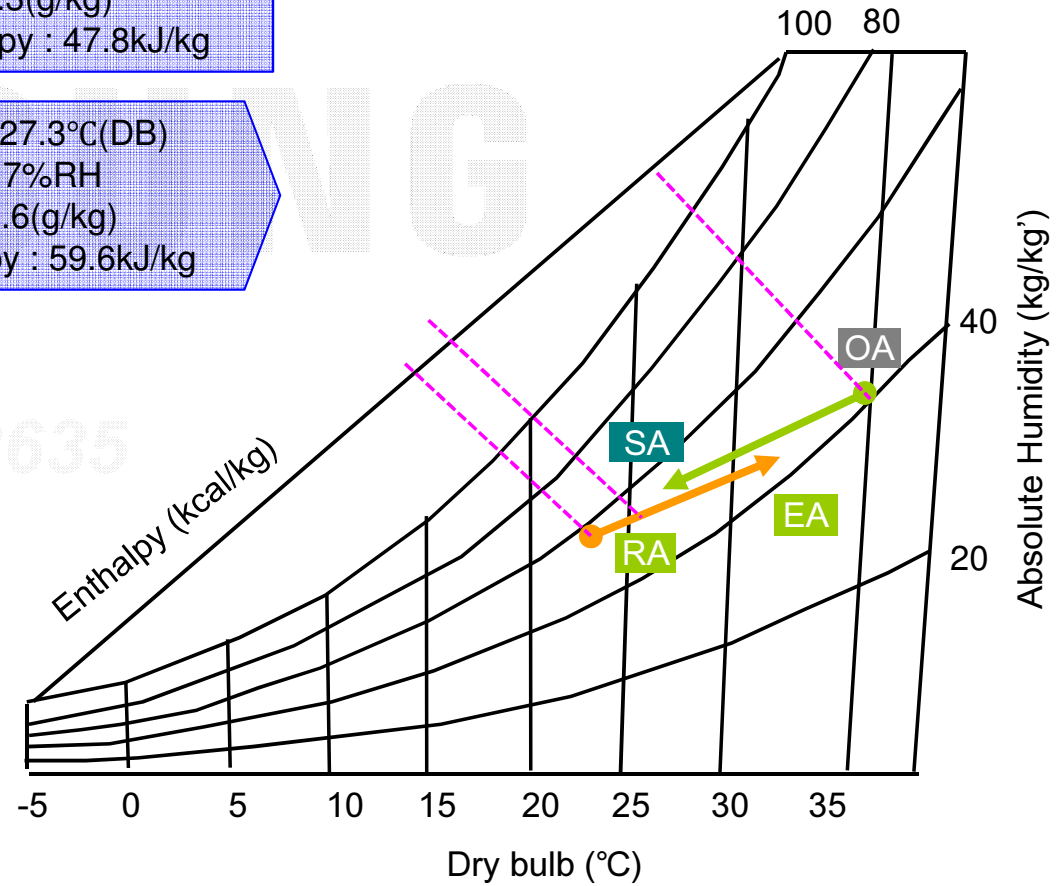

Line up

- Line up
- Specification

SAMSUNG

15552635

Line up

Operating temperature	Installation area	Room	Outdoor
Temperature[°C]	0~40	0~40	-15~40
Related humidity[%]	80 or low	80 or low	80 or low

Airflow (m ³ /hr)	250	350	500	800	1000
Picture					
New Model (NASA)	AN026JSKLKN	AN035***	AN050***	AN080***	AN100***
Old Model (Non NASA)	RH025***	RH035***	RH500***	RH800***	RH100***

Specification

Model Name			AN026JSKLKN	AN035JSKLKN	AN050JSKLKN	AN080JSKLKN	AN100JSKLKN	
Power Supply		-	1,2,220-240,50/60	1,2,220-240,50/60	1,2,220-240,50/60	1,2,220-240,50/60	1,2,220-240,50/60	
Power Input	Turbo	W	115	115	175	330	450	
	High	W	80	80	120	230	280	
	Low	W	45	50	65	125	155	
Current		A	0.7	0.7	1.1	2.1	2.9	
Airflow	Turbo/High/Low	CMH	260 / 250 / 180	350 / 350 / 256	500 / 500 / 360	800 / 800 / 560	1000 / 1000 / 690	
E.S.P	Turbo/High/Low	Pa	100 / 65 / 55	155 / 100 / 83	165 / 100 / 85	155 / 90 / 80	155 / 90 / 75	
Temperature Exchange Efficiency	Cool	T / H / L	%	70 / 70 / 74	70 / 70 / 74	70 / 70 / 74	70 / 70 / 74	70 / 70 / 74
	Heat	T / H / L	%	74 / 74 / 75	78 / 78 / 79	74 / 74 / 75	77 / 77 / 78	74 / 74 / 75
Enthalpy Exchange Efficiency	Cool	T / H / L	%	50 / 50 / 55	50 / 50 / 55	50 / 50 / 55	50 / 50 / 55	50 / 50 / 55
	Heat	T / H / L	%	70 / 70 / 76	70 / 70 / 76	70 / 70 / 76	70 / 70 / 76	70 / 70 / 76
Sound Pressure	Turbo/High/Low	dB	31 / 28 / 25	32 / 29 / 26	35 / 32 / 28	36 / 33 / 29	37 / 34 / 30	
	Quiet	dB	22	23	24	25	26	
Duct size		mm	150	200	200	250	250	
Net weight		kg	28.5	42.5	42.5	67	67	
Net dimensions(W x H x D)		mm	600 x 350 x 600	1012 x 270 x 1000	1012 x 270 x 1000	1220 x 340 x 1135	1220 x 340 x 1135	

- Heat Exchange/Temperature Exchange Efficiency, Comply with regulations to promote high efficiency energy devices,

[Cooling], Indoor(24°C DB/17°C WB), Outdoor(35°C DB/24°C WB)

[Heating], Indoor(22°C DB/13.9°C WB), Outdoor(2°C DB/0.44°C WB)

Features

- Energy saving
- Smart Co2 censor
- Flexible installation
- Bypass mode
- Energy saving mode
- External damper interlocking
- Hood interlocking

SAMSUNG

15552635

Features

■ Energy saving

- ✓ Save the ventilation energy up to 70%

ERV recover the heat energy of exhausted air and reuse it for supply air. This maintains the indoor temperature and humidity during the winter, and prevents outdoor heat and moisture from entering indoors during the summer.

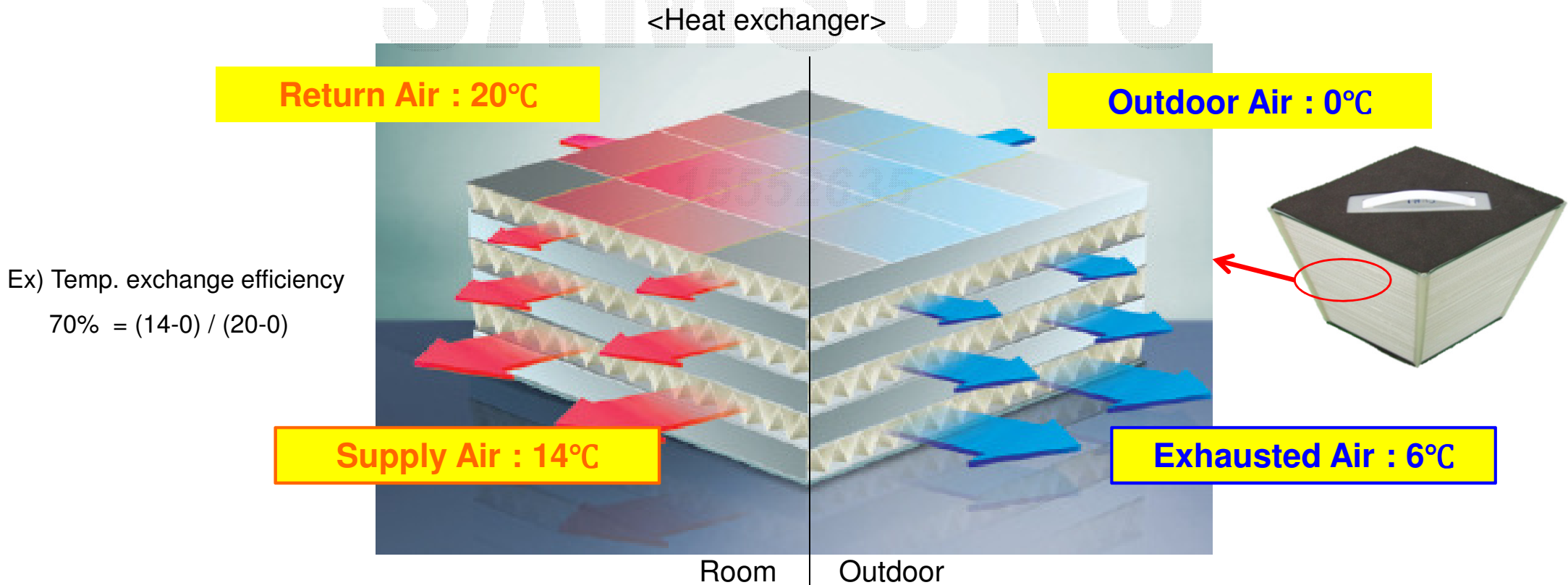

Features

■ Smart Co2 sensor

ERV is automatically operated to give fresh air into room by sensing CO2 level.

When the CO2 level increases, the fan will automatically increase speed.

Only the amount of air required to keep the CO2 level on an acceptable level will be ventilated.



Model : MOS-C1(optional)

Airflow by CO2	Non NASA	NASA
Turbo	1200ppm ↑	900ppm ↑
Low	800ppm ↓	650ppm ↓

* CO2 Concentration value can be changed.
Refer to installation manual (Installation 05 SEG22)

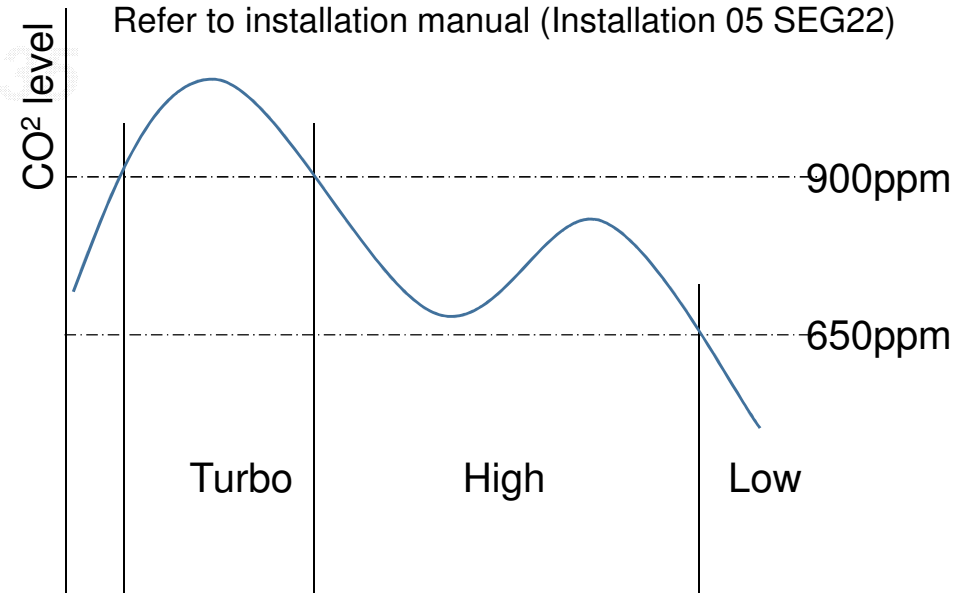

Features

■ Virus doctor

Virus doctor provides the healthy and clean environments by removing viruses, fungi and allergens from the air you breathe everyday.



INFLUENZA VIRUS

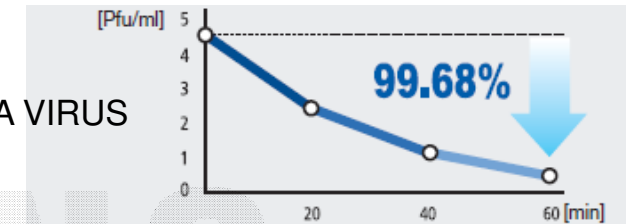

CORONA VIRUS

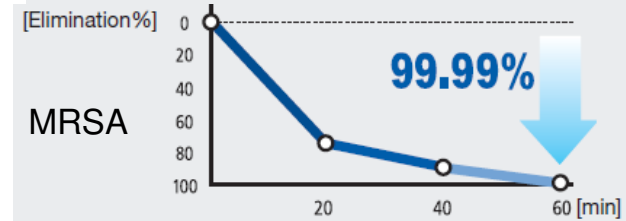
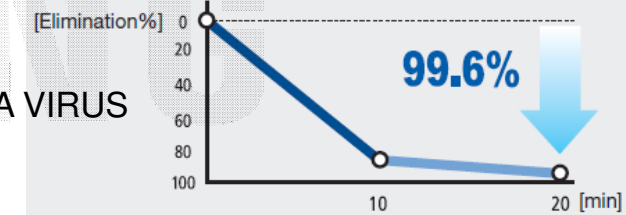

► How it work : Virus doctor generates active hydrogen(H) and oxygen ions(O₂⁻) which eliminate biological contaminants and active oxygen

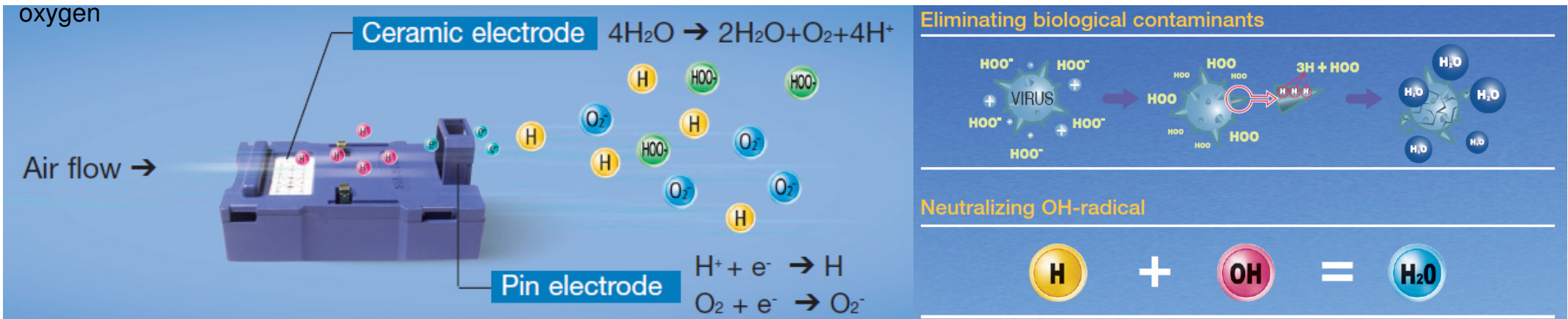

Features

■ Flexible installation

The ERV system can be installed Upside down. This feature will save you time on maintenance when installing more than one unit, since you can reduce the number of service hole by installing the ERV with the control box facing **one service hole**.

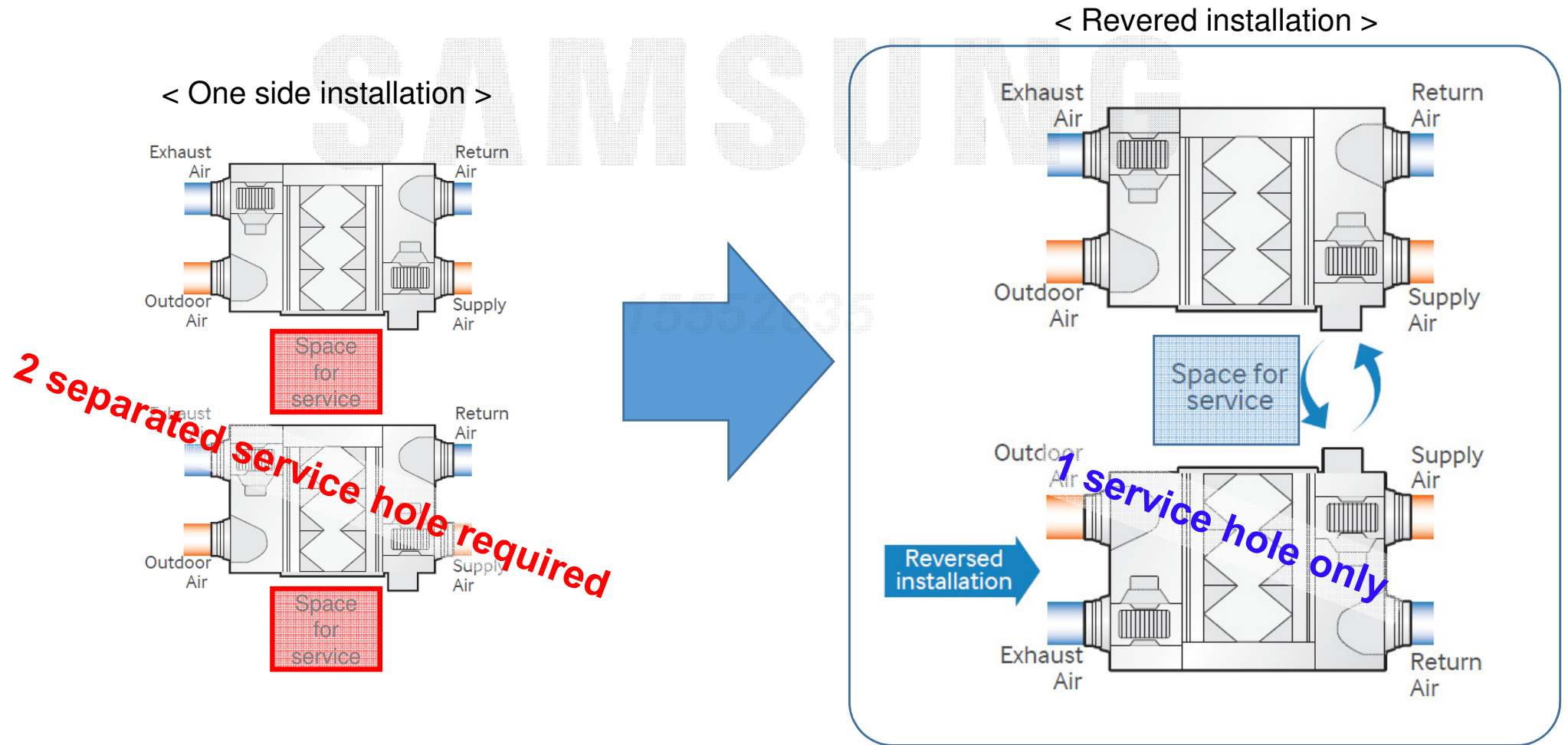

Features

■ Bypass mode

ERV automatically changes its operation mode depending on the temperature difference between your indoor and outdoor environment to save energy. (Manual selection also available)

Extreme Climates (Winter & Summer)

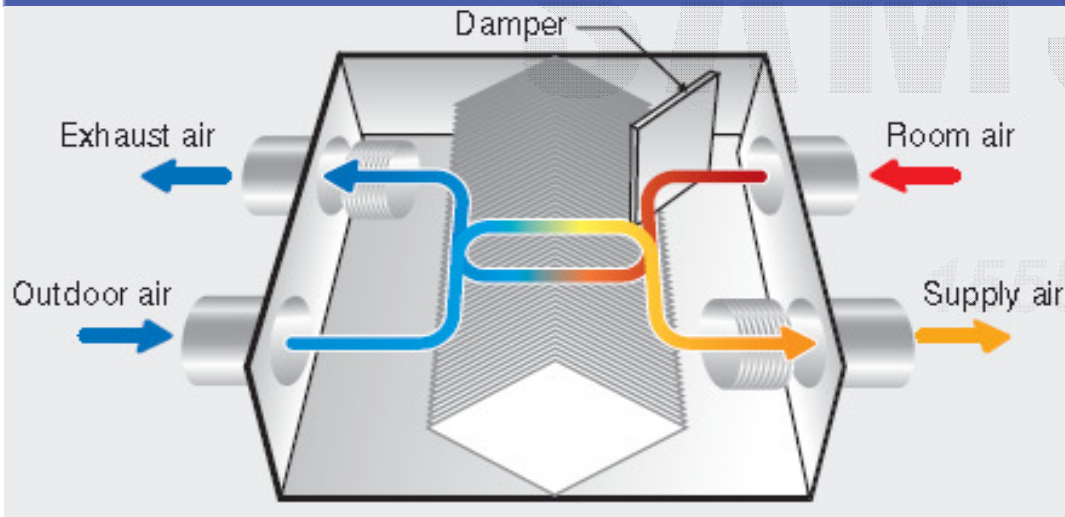

The unit operates as ERV when there is a great difference in the temperature and humidity level between your indoor and outdoor environment.

Mild Climates (Spring & Fall)

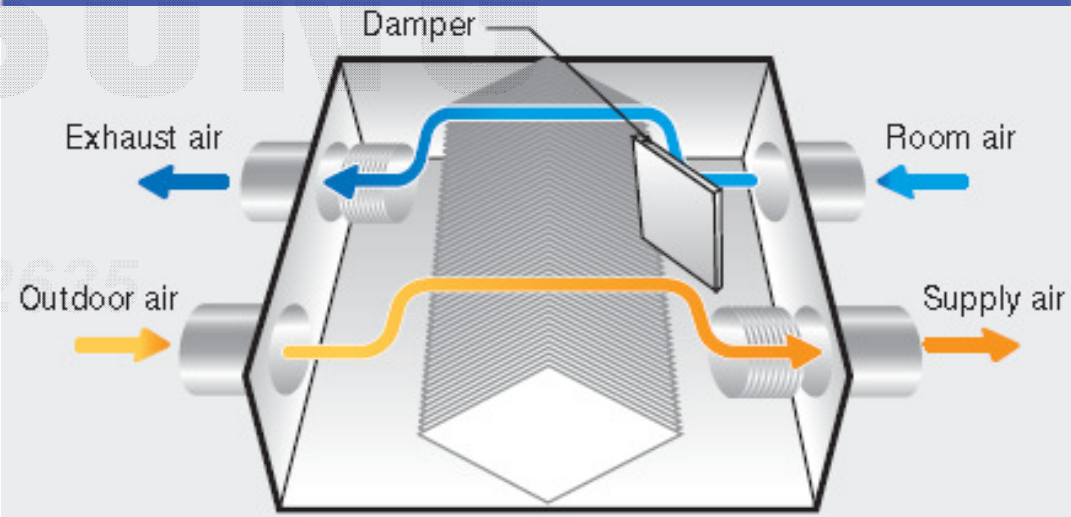

When the temperature and humidity level difference between your indoor and outdoor is small, it operates as conventional ventilation fan.

Features

■ Energy saving mode (Interlocking with DVM indoor units)

ERV, in combination with air conditioners, provides world-class energy saving solutions to intelligently reduce air conditioner operation hour. This reduces the cooling and heating load while maintaining optimized performance.

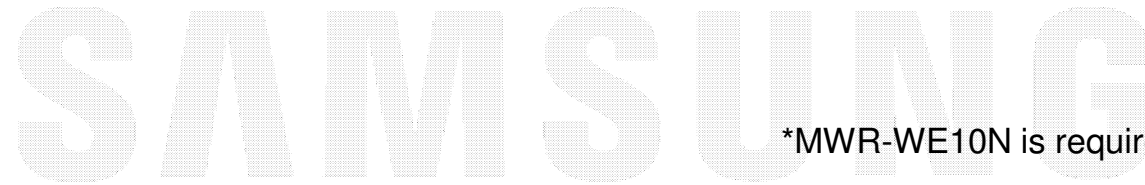

*MWR-WE10N is required



ERV only - Bypass mode



ERV + DVM Indoor unit

15552635

Features

■ External damper interlocking

External damper will be controlled by ERV operation to prevent cold or hot air get in to the room.
Also it can prevent dewing on the heat exchanger in winter.



Features

■ Hood interlocking

When hood is on ERV will operate in “**hood mode**” to prevent smell get in to the room.

* Hood mode : Supply air ↑, exhaust air ↓ → positive pressure in the room.

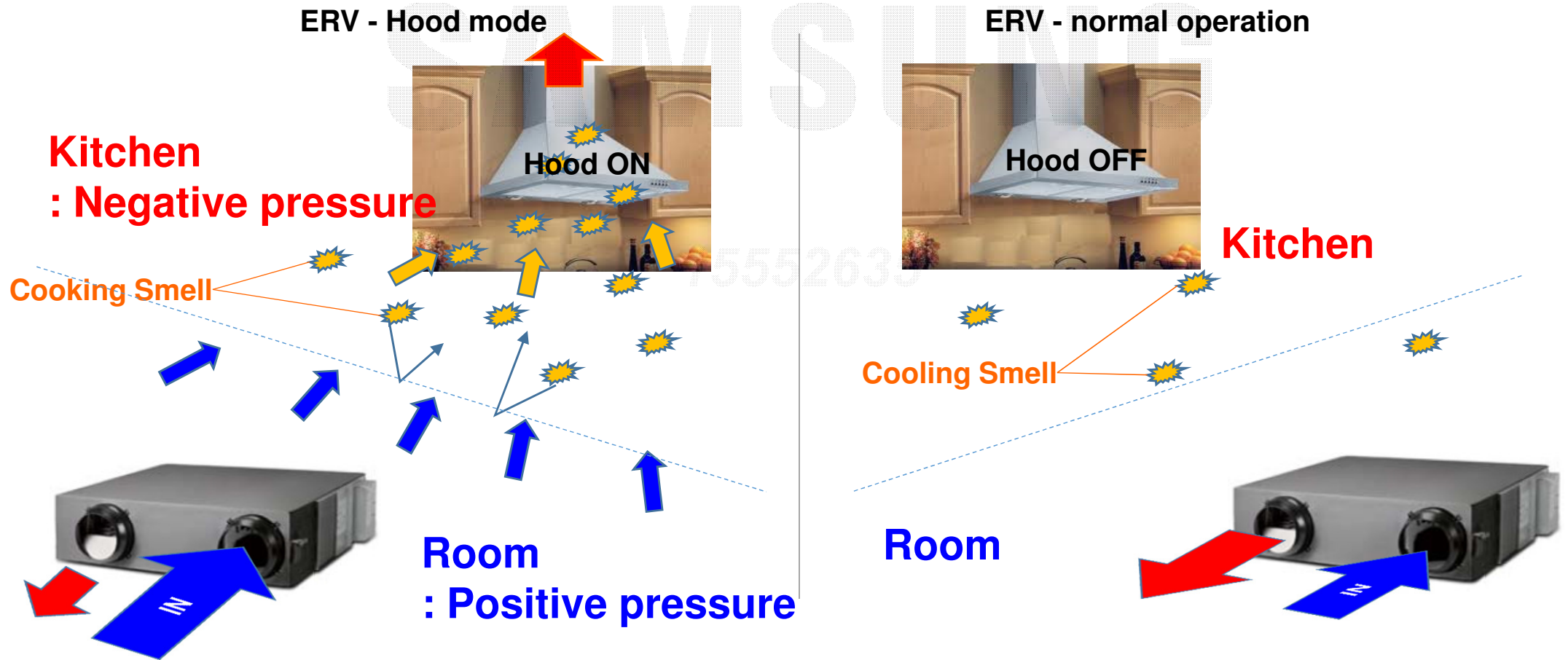

Part analysis

- Major parts
- PBA

SAMSUNG

15552635

Part analysis

■ Major parts

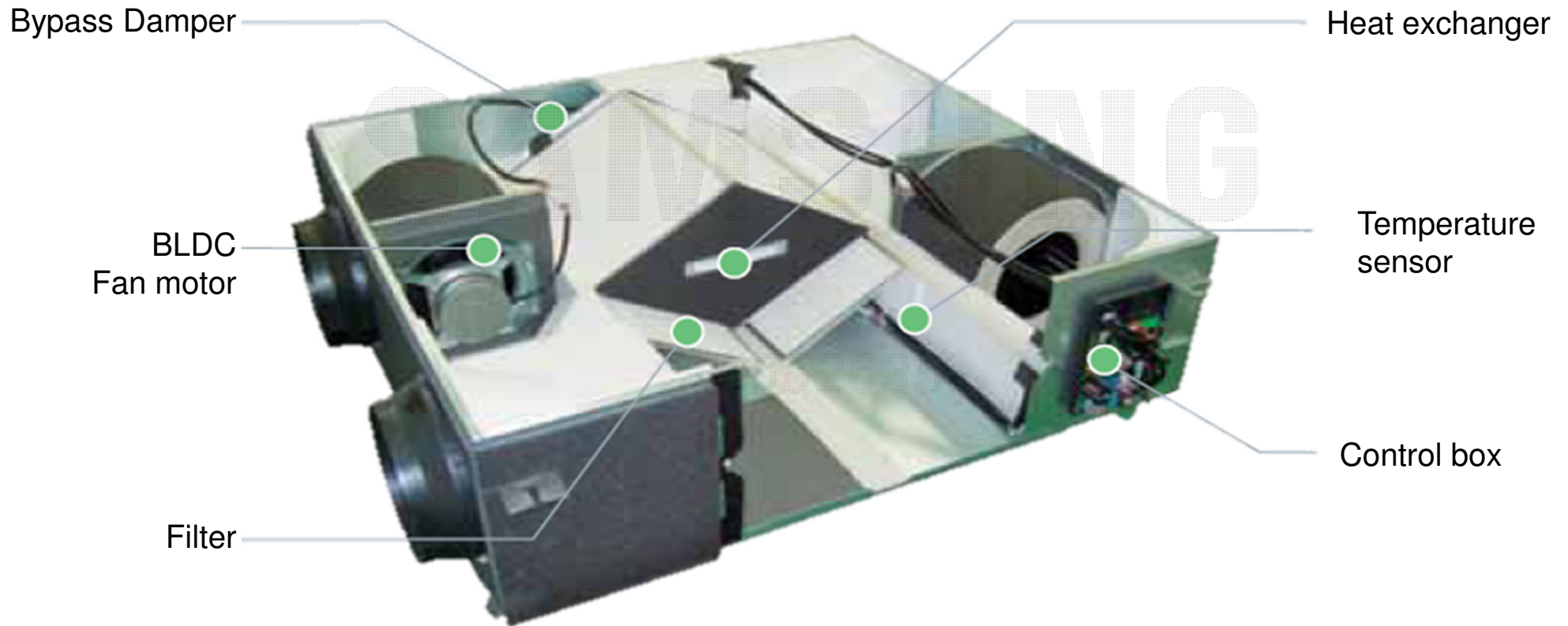

Part analysis

■ PBA

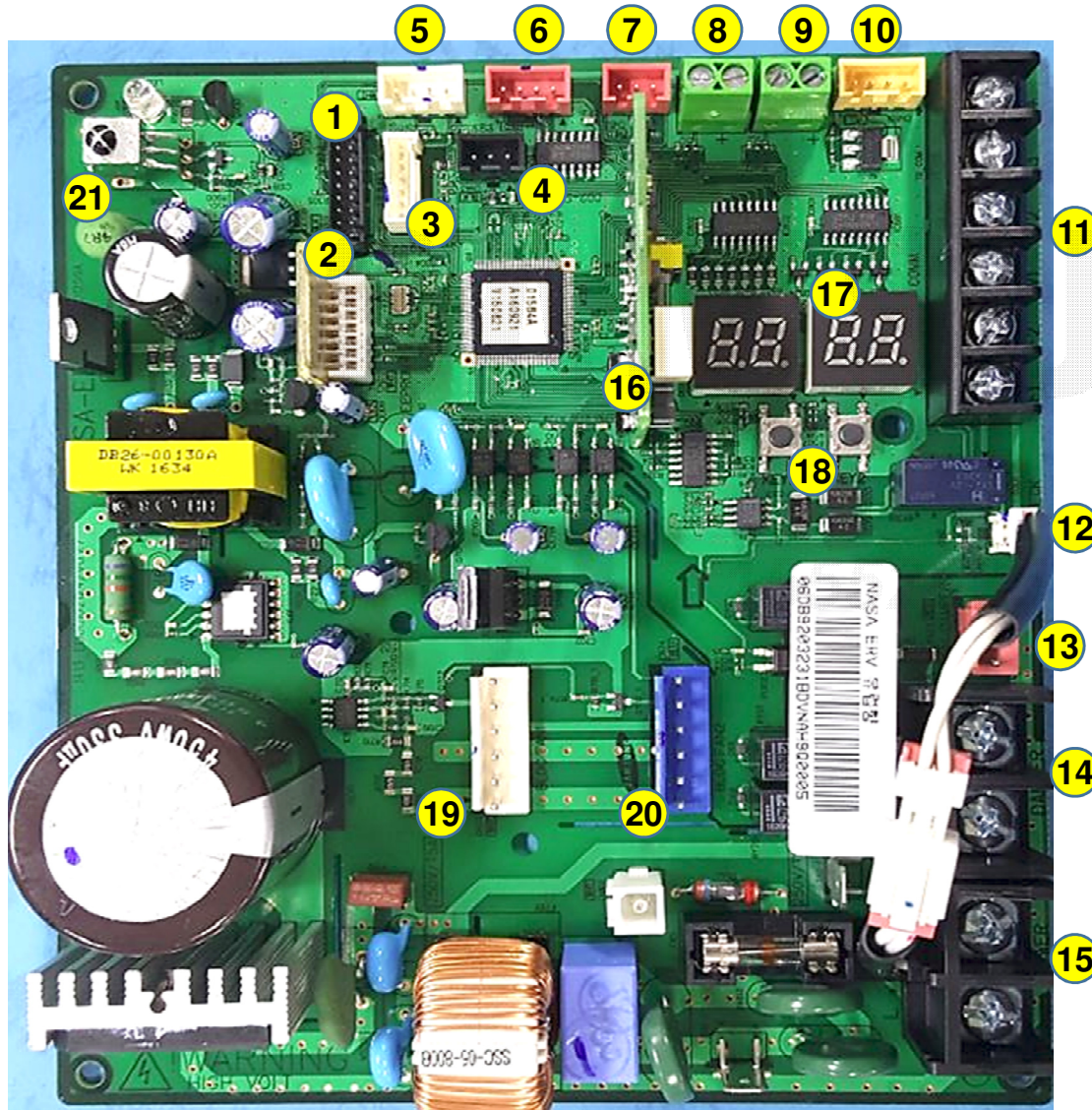

1	download
2	eprom
3	Humidifier sensor
4	CO2 sensor
5	Temperature sensor
6	MIM-B14(Run/Error output)
7	Bypass damper connector
8	External contact input - Hood mode
9	External contact - On/off
10	Virus doctor
11	Comm.(F1,2 / V1,2 / F3,4)
12	Thermal fuse
13	Bypass Damper power connector
14	External damper power
15	Power terminal
16	PLC PBA(wired RC comm.)
17	Display
18	Tact key
19	EA motor power
20	SA motor power
21	Wireless signal receiver

How to design

- Design process
- Ventilation rates
- Control system

15552635

How to design

■ Design process

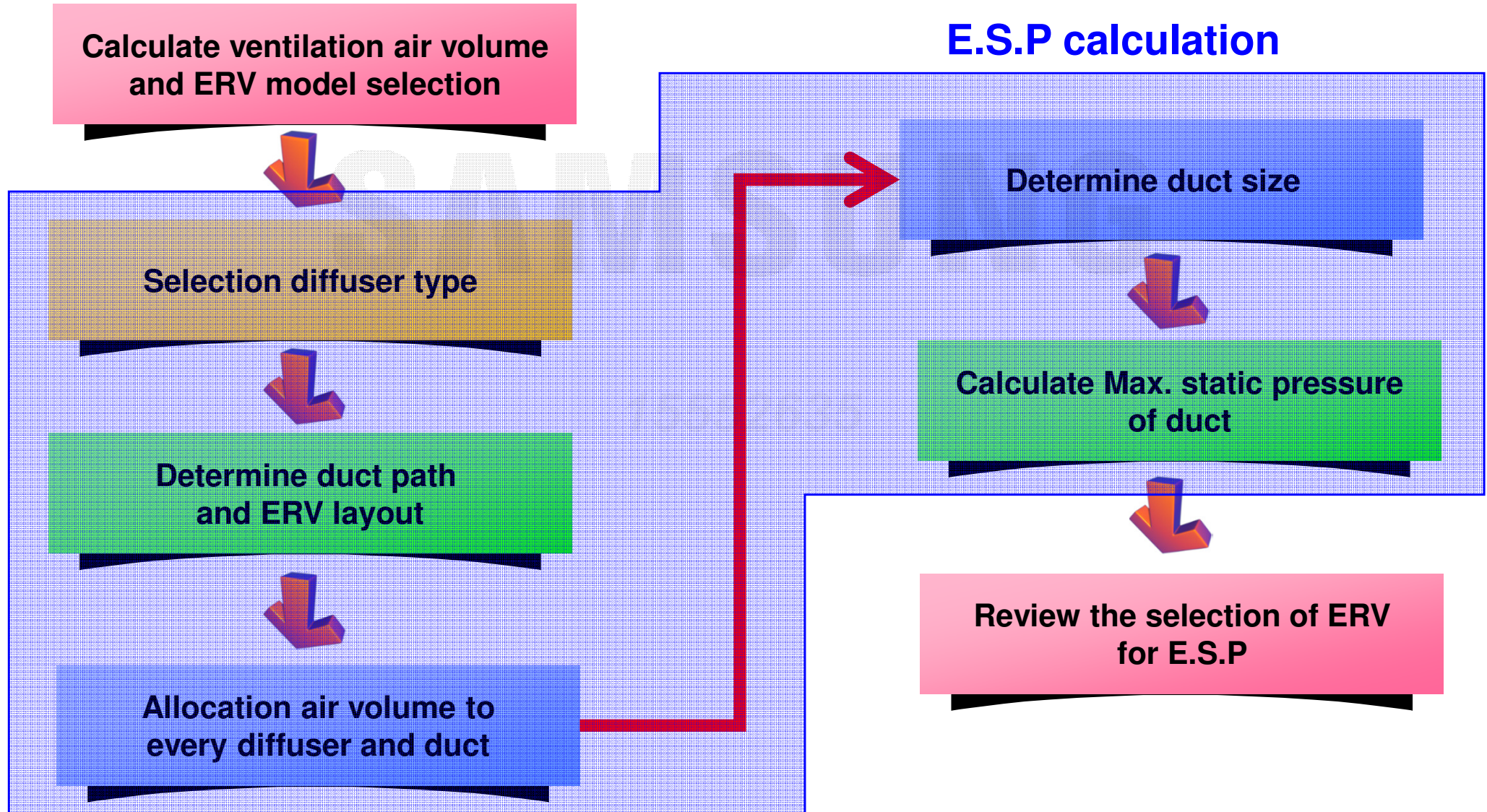

How to design

■ Ventilation rates

* Minimum Ventilation rates will be decided by the law of each country.

1 . Calculation by Fresh air Requirement per Person

- Ventilation rates(m^3/h) = Fresh air requirement[CMH/Person] X Number of occupants[Person]

Space	Fresh air[CMH/Person]	Space	Fresh air[CMH/Person]
Restaurant	25	Class room	20
Kitchen	25	Theater	25
Hospital – ward	30	Office	25

2. Calculation by Air change rate (when no information about number of occupants)

- Ventilation rates(m^3/h) = Volume(m^3) X Required ventilation time per hour

Space	Air change rate[time/h]	Space	Air change rate[time/h]
Restaurant	6	School - gym	5~10
Kitchen	5~15	Theater	6
Hospital – ward	6	Office	3~10

* ASHRAE recommends ventilation rates dependent upon floor area, as a revision to the 62-2001 standard, in which the minimum ACH(Air change rate/h) was 0.35, but no less than 15 CFM/person (15 CFM/person = $0.425m^3/s \cdot person = 25m^3/h \cdot person$).

How to design

■ Calculate ventilation air volume – Example

* Use ERV simulation program

✓ Design condition

- Type : Office
- Maximum occupant : 30person
- Design temperature : Cooling - ID 24°C 50%RH, OD 35°C 40%RH
- E.S.P : 120Pa

1. Ventilation rate : 30person x 25CMH = 750CMH

2. Model selection : Select by ventilation rate

Model	AN025***	AN035***	AN050***	AN080***	AN100***
Airflow rate(CMH)	250	350	500	800	1000
E.S.P[Pa]	110	155	165	155	155
Selection	X	X	X	O	△

3. Energy saving result

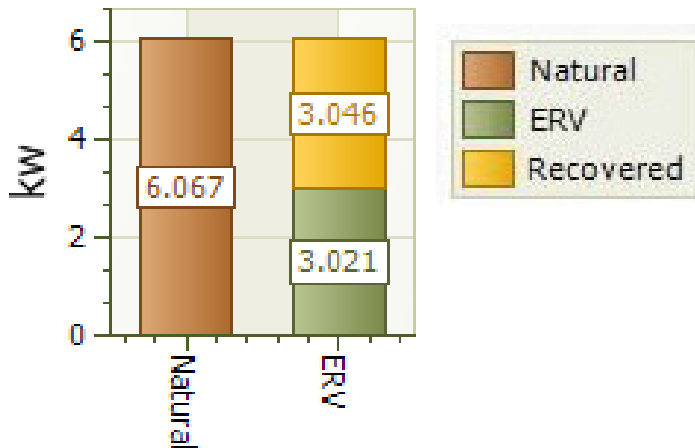

Temp : 35°C(DB)
RH : 40%RH
AH : 14.1(g/kg)
Enthalpy : 71.5kJ/kg

Temp : 31.7°C(DB)
RH : 37%RH
AH : 10.8(g/kg)
Enthalpy : 59.6kJ/kg

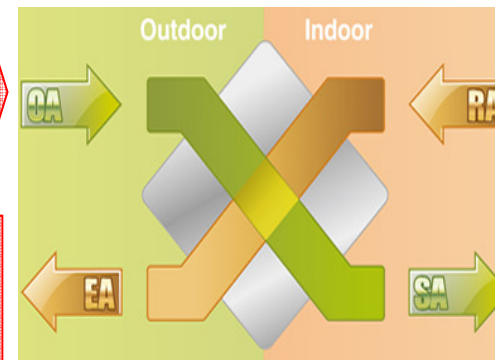

Temp : 24°C(DB)
RH : 50%RH
AH : 9.3(g/kg)
Enthalpy : 47.8kJ/kg

Temp : 27.3°C(DB)
RH : 55.7%RH
AH : 12.6(g/kg)
Enthalpy : 59.6kJ/kg

How to design

■ Practice 1

✓ Design condition.

- Type : Office
- Maximum occupant : 20person
- Design temperature : Cooling - ID 22°C 50%RH, OD 33°C 40%RH

1. Calculate required ventilation rate

2. Select proper ERV model

Model	AN026***	AN035***	AN050***	AN080***	AN100***
Airflow rate(CMH)	260	350	500	800	1000
E.S.P[Pa]	100	155	165	155	155

3. How much energy[kW] saved by using selected ERV model.

* Assume energy efficiency of AC as cooling 3.0kW/kW, heating 4kW/kW

Category	Cooling	Heating
Saved ventilation load by ERV[kW]		
Energy saving by ERV[kW]		

How to design

■ Practice 2

- ✓ Design condition.
 - Type : Restaurant
 - Maximum occupant : 100person
 - Design temperature : Cooling - ID 25°C 50%RH, OD 38°C 40%RH

1. Calculate required ventilation rate

2. Select proper ERV model

Model	RHF025***	RHF035***	RHF050***	RHF080***	RHF100***
Airflow rate(CMH)	250	350	500	800	1000
E.S.P[Pa]	110	155	165	155	155

3. How much energy[kW] saved by using selected ERV model.

* Assume energy efficiency of AC as cooling 3.0kW/kW, heating 4kW/kW

Category	Cooling	Heating
Saved ventilation load by ERV[kW]		
Energy saving by ERV[kW]		

How to design

■ Control system

✓ Wired remote controller

- 1wired remote controller with multiple ERV

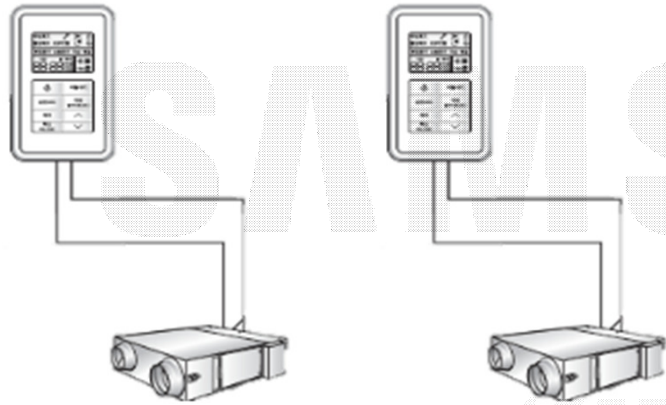

- 1wired remote controller with multiple ERV(Max 16ea)

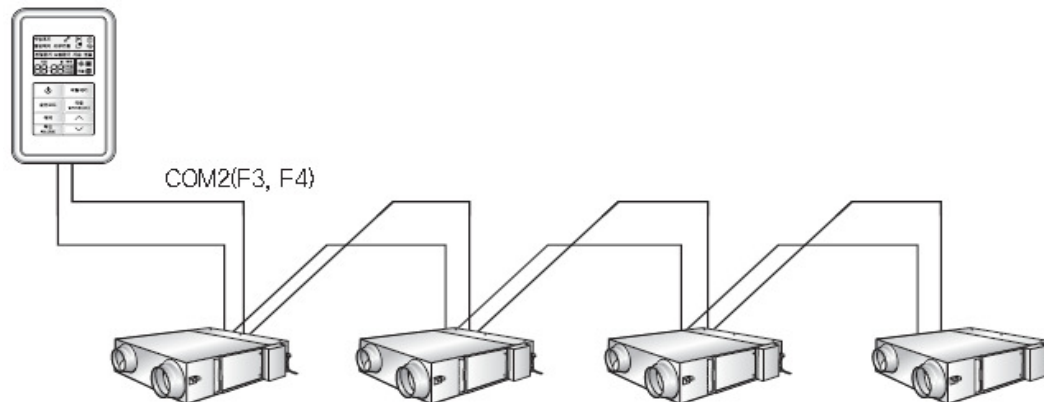

How to design

- Control system
 - ✓ Centralized controller

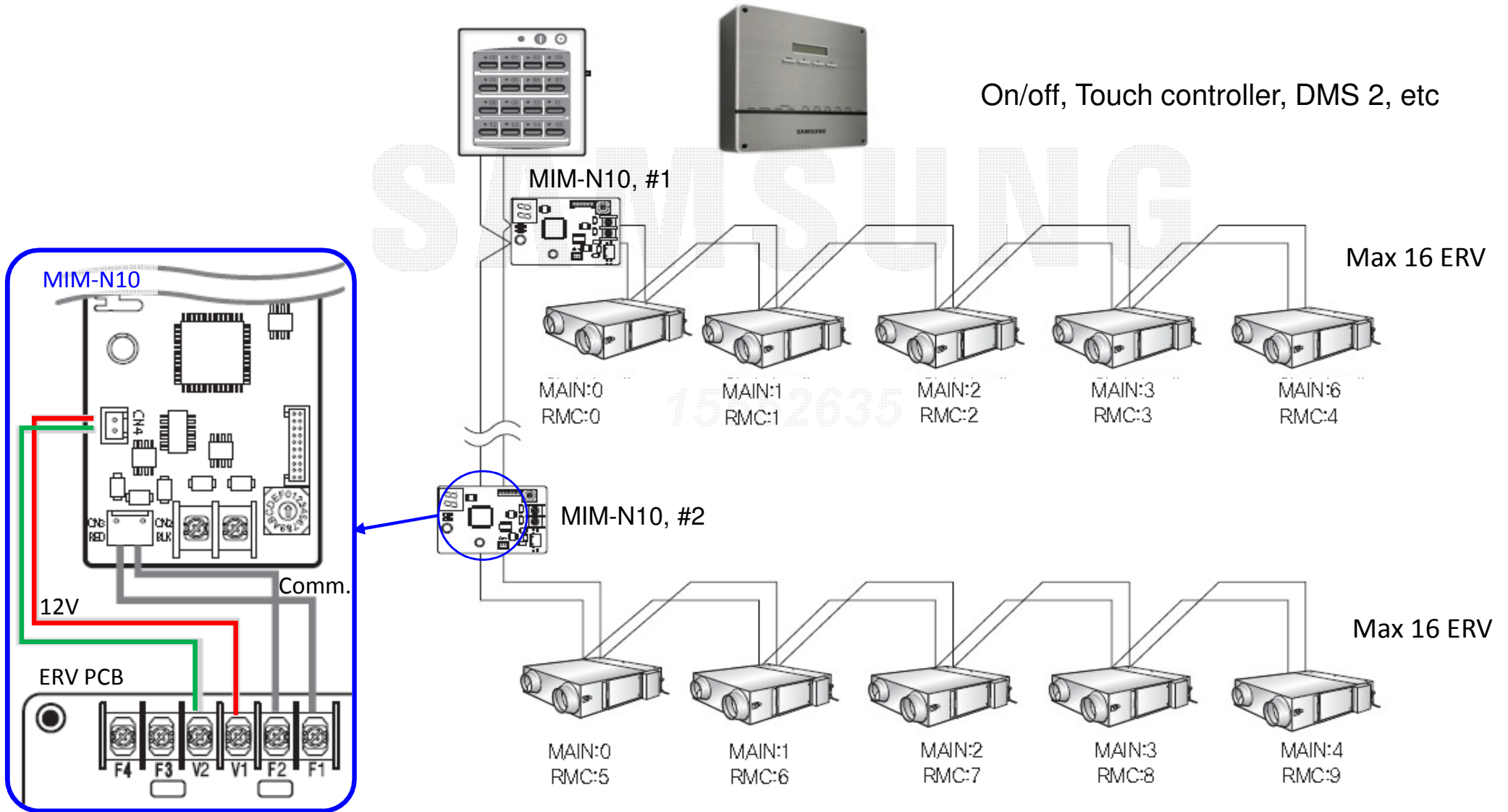

How to design

■ Control system

✓ Interlocking system

- External damper control

: Output signal 220V, Max 2.0A

* If the maximum current is over 2.0A do not use this as power source but relay signal

* Damper must be supplied from local market

ERV		Signal		Damper
On	➡	Close	➡	Open
Off	➡	Open	➡	Close

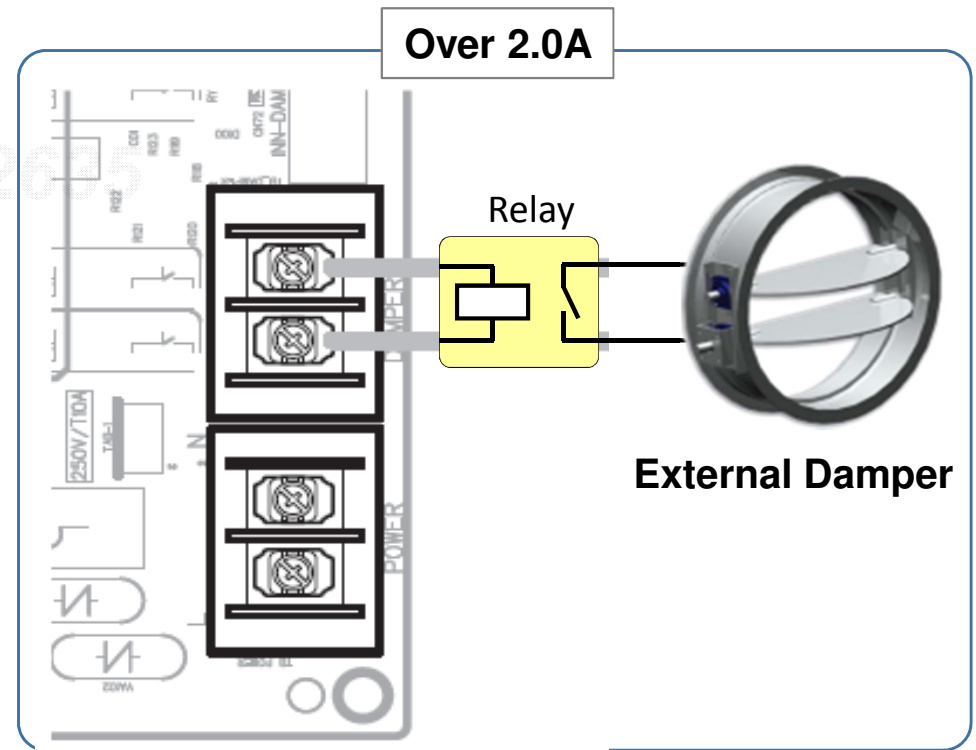
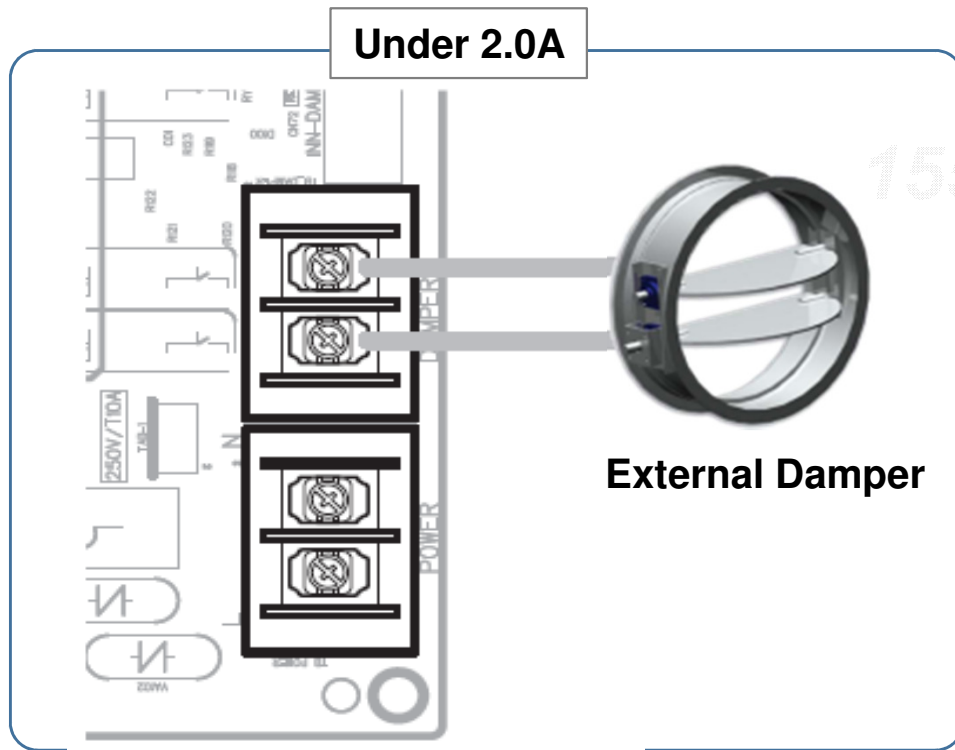

How to design

■ Control system

✓ Interlocking system

- 2kinds of External control with dry contact

▷ Hood : if the signal is close, S.A = Turbo, E.A = Low to make a positive pressure in the space.

(Hood can exhaust smell easily)

▷ EXT1 : Signal close = ERV on, Signal open = ERV off

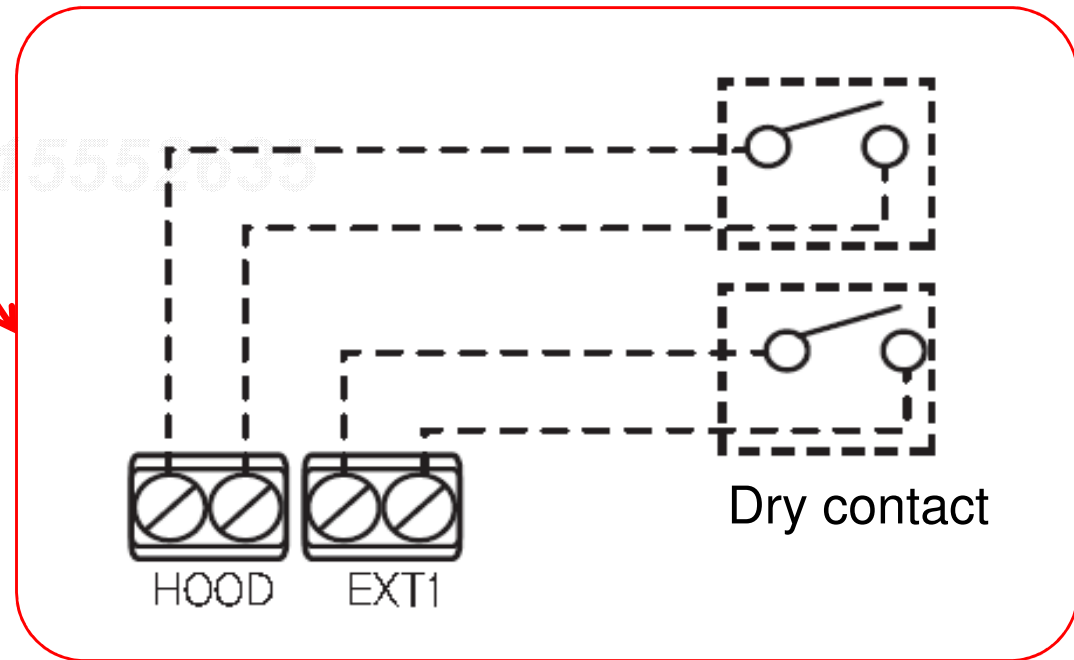
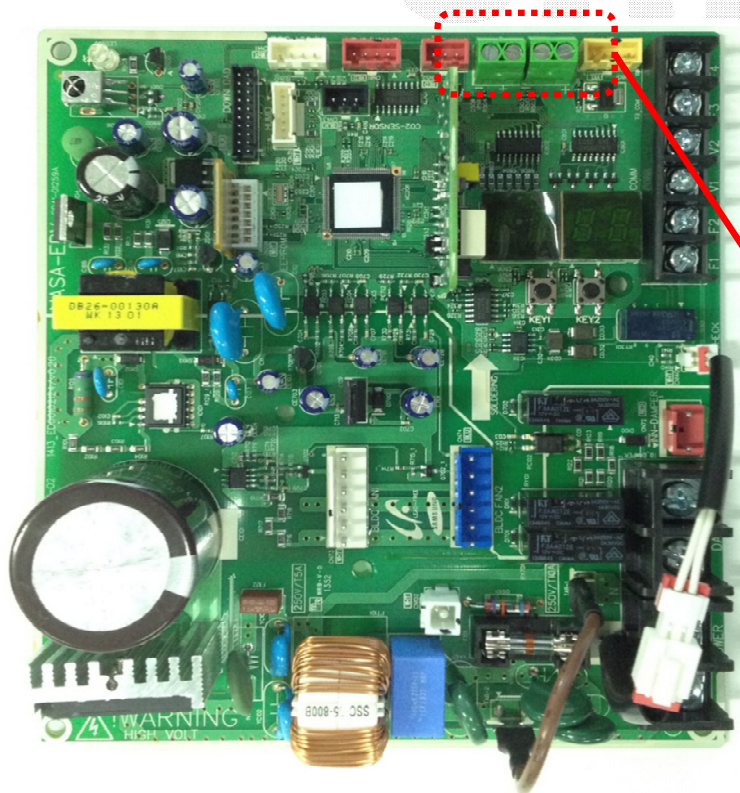

How to install

- **Installation condition**
- **Installation diagram**
- **Address setting**
- **Installation option setting**
- **Display**
- **Tact key function**

15552635

How to install

■ Installation condition

Category	Installation space	Outdoor air condition	Indoor air condition
Temperature	0~40°C	-10~40°C	10~40°C
Humidity	RH80% ↓	RH80% ↓	RH80% ↓

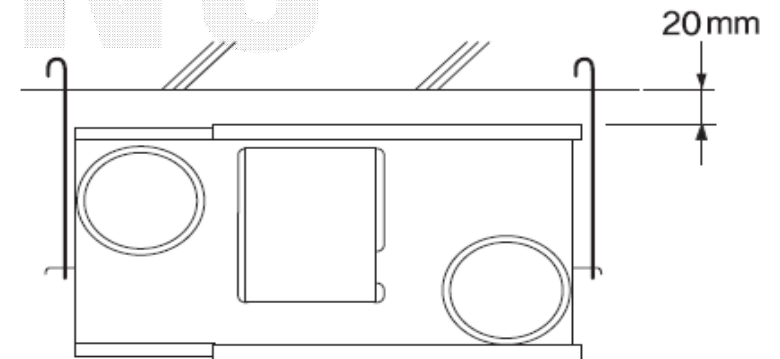
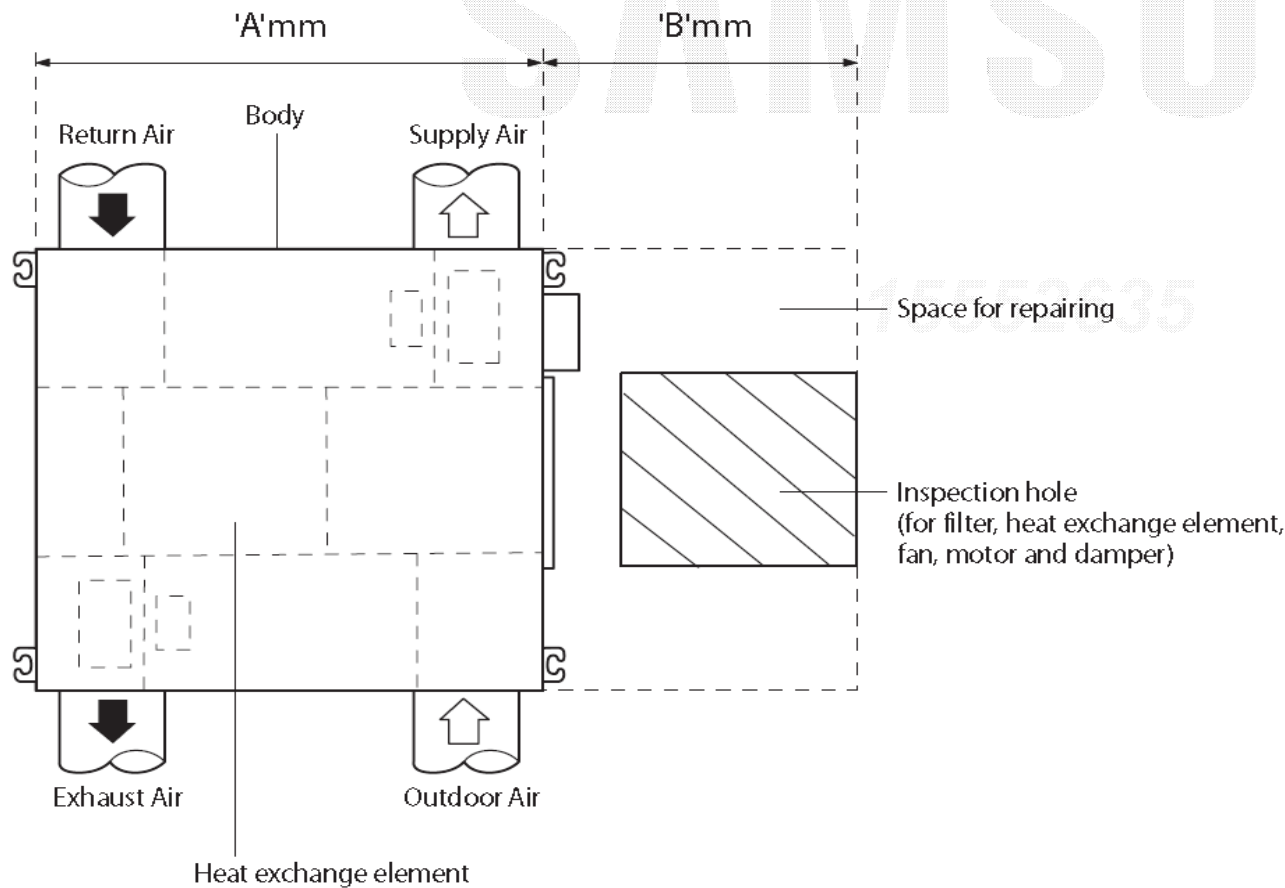

Model	'A'	'B'
035/050	1000	600
080/100	1135	800

How to install

■ Installation diagram

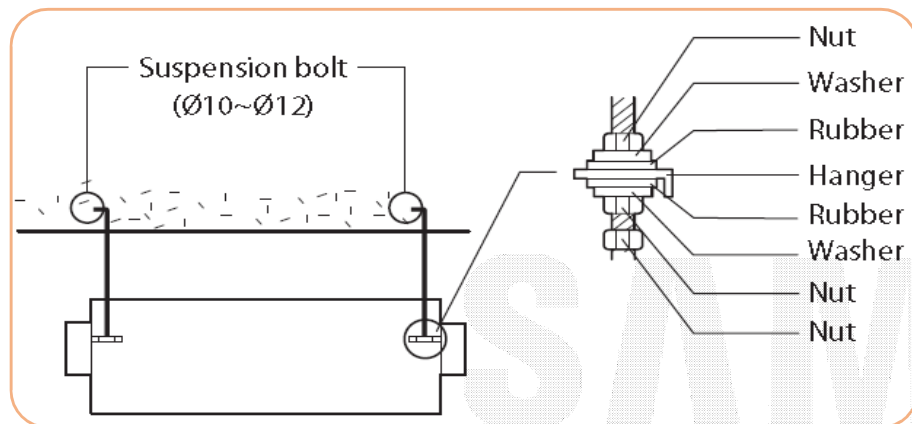

(Unit : mm)

Model	Nominal diameter for duct
035/050	Ø200
080/100	Ø250

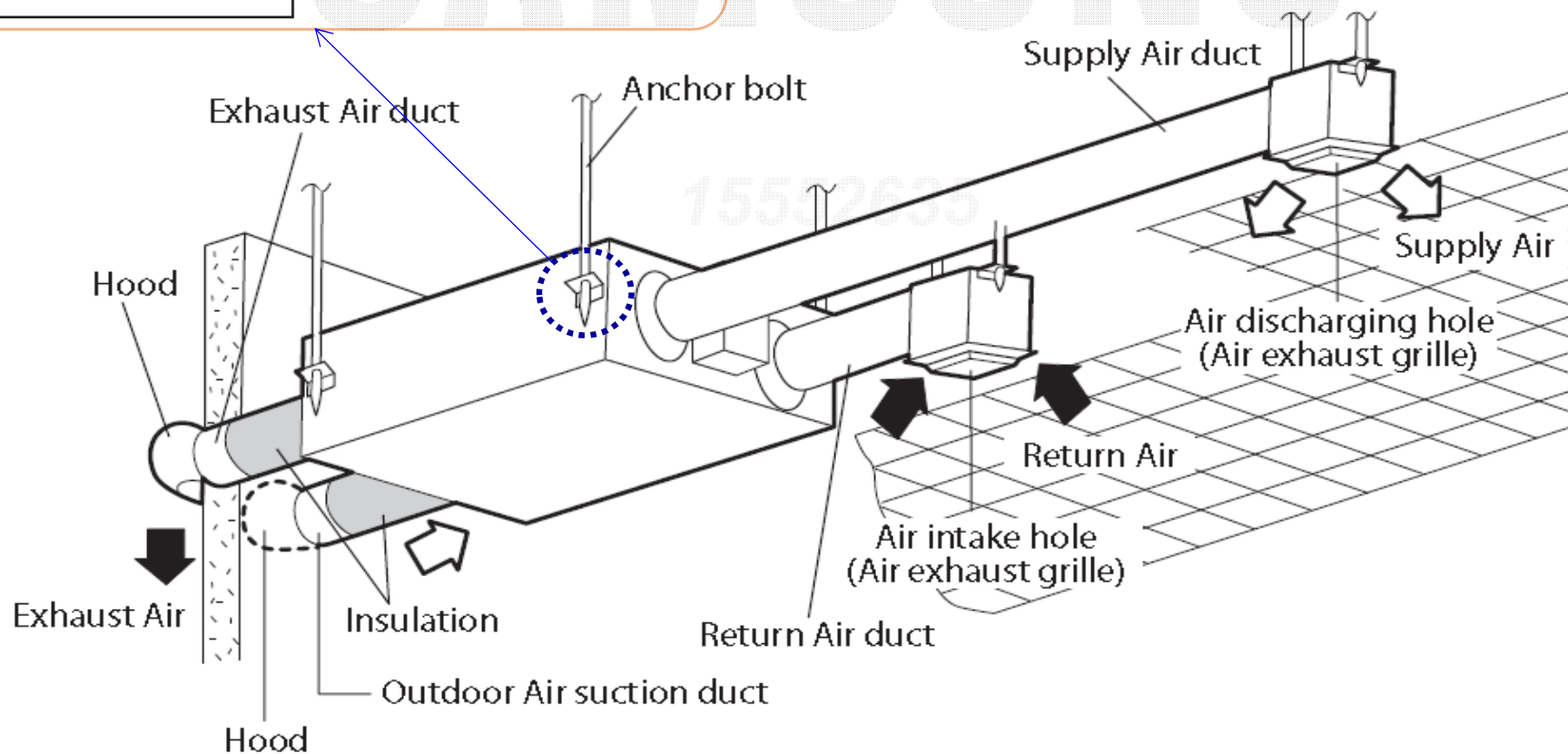

How to install

■ Address setting

Option No. : 0AXXXX-1XXXXX-2XXXXX-3XXXXX

Option	SEG1		SEG2		SEG3		SEG4		SEG5		SEG6	
Explanation	PAGE		Mode		Setting Main address		100-digit of indoor unit address		10-digit of indoor unit		The unit digit of an indoor unit	
Remote Controller Display												
Indication and Details	Indication	Details	Indication	Details	Indication	Details	Indication	Details	Indication	Details	Indication	Details
	0		A		0	No Main address	0~9	100-digit	0~9	10-digit	0~9	A unit digit
Option	SEG7		SEG8		SEG9		SEG10		SEG11		SEG12	
Explanation	PAGE				Setting RMC address				Group channel(*16)		Group address	
Remote Controller Display												
Indication and Details	Indication	Details	—		Indication	Details	—		Indication	Details	Indication	Details
	1				0	No RMC address			RMC1	0~F	RMC2	0~F
					1	RMC address setting mode						

How to install

■ Installation option setting

Use wired or wireless remote controller to set the option.

* Wireless signal receiver is added.

Installation option	Seg	Option	Set
02	5	Centralized controller	0 : Disuse
			1 : Use
	16	Virus doctor	0 : Disuse
			1 : Use
	18	Filter alarm	2 : 1000 hours
			6 : 2000 hours
05	14	Co2 Sensor	0 : Disuse
			1 : Use
	15	External Damper	0 : Disuse
			1 : Use

How to install

■ Display

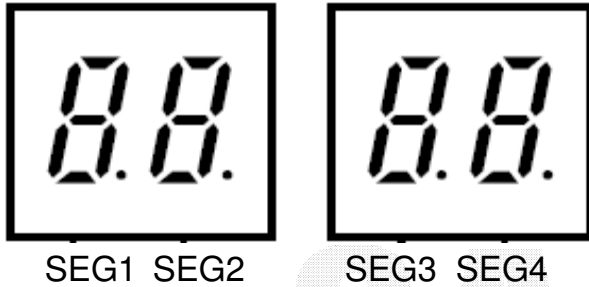

SEG 1 : Displays "U" when an indoor unit communicates with a wired remote controller

SEG 2 : RMC2 address(0~F)

SEG 3 & 4 : Main address(00~15)

15552635

Example)



1. Wired remoter controller is connected
2. RMC2 address is "7"
3. Main address of ERV is "08"

How to install

■ Tact key function

K1 Push	Function	example	Segment			
			SEG1	SEG2	SEG3	SEG4
1	Test Run start	-	┆	1	-	-
2	Test run stop	-	-	-	-	-

K2 Push	Display	example	Segment			
			SEG1	SEG2	SEG3	SEG4
1	Exhaust fan RPM	1350RPM	1	1	3	5
2	Supply fan RPM	950RPM	2	-	9	5
3	Room temp.	25°C	3	-	2	5
4	Outdoor temp.	30°C	4	-	3	0
5	Co2 level	1,220ppm	5	1	2	2
6	ERV quantity	3units	6	-	-	3
7	Indoor Humidity(ERV+only)	40(if no function 00)	7	-	4	0
8	Outdoor Humidity(ERV+only)	50(if no function 00)	8	-	5	0
9	None	--				

▶ When you press and holde the KEY2 switch for more than 3 seconds, PBA will be reset (in 40sec.)

Application

- Bypass control in Auto mode (Ventilation only)
- Self adjustment in low temperature
- IDU + ERV on/off control
- Wired remote controller setting
- E. Saver
- Tact key function

Application



■ Bypass control in Auto mode(Ventilation only)

When the system is operating in Auto mode, bypass damper will be controlled automatically according to the ΔT .

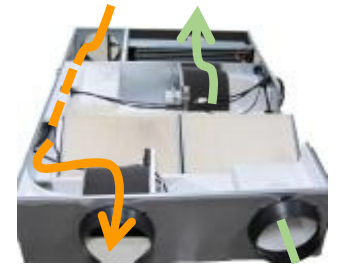
**Bypass damper will be fixed for minimum 30mins with selected mode*



ΔT : room temperature - ambient temperature

Condition	Operation Type	Bypass Damper
$\Delta T \geq \pm 5^{\circ}\text{C}$	Normal operation(heat exchange mode)	Close 
$\Delta T < \pm 5^{\circ}\text{C}$	Operation as a convention ventilation fan(Bypass mode) New (*Installation option : 05 Seg. 21) Room temp. > Fresh air cooling set temp. \geq Outdoor temp.(15°C) *Fresh air cooling set temp. range : 18°C~ 26°C	Open 

* Refer to installation manual.

Application

■ Self adjustment in low temperature

- ✓ Self adjustment depending on outdoor temperature to prevent it from being iced on element.
(This will be ignored when the ERV is in bypass mode)

Outdoor Temp	Operation Type	Supply	Exhaust
Above 0°C	Normal Operation	On	On
0 °C > T _{OA} > -5 °C	“A” Type Cyclic Operation	Refer to below operation pattern	
-5 °C > T _{OA} > -10 °C	“B” Type Cyclic Operation		
-10 °C > T _{OA} > -15 °C	“C” Type Cyclic Operation		
Below -15 °C	Stop the ERV	Off	Off

15552635

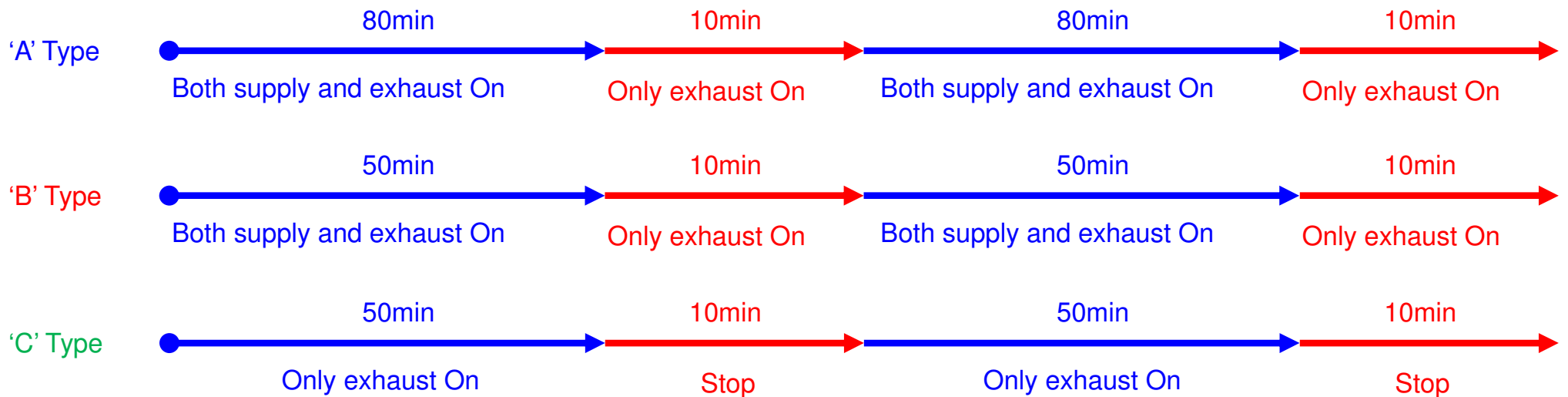

Application

■ IDU + ERV on/off control

✓ User mode(MWR-WE10N)

7	Ventilator (ERV) delay time setting/checking [When using Ventilator (ERV) interlocking control]	Ventilator(ERV) Delay Application (Y/N)	1	0	0-No use, 1-Use	-
		Delay Time	3,4	30	30~60 minutes	1 minute

If indoor unit & ERV is controlled by 1 remote controller & AC on/off button is set as "1 (IDU+ERV)"
 → AC on button push : Indoor unit on & ERV will be on in 30mins.

✓ SVC mode(MWR-WE10N)

1	2	AC On/Off button function	5	0	0 - Indoor unit + ERV, 1 - Indoor unit only, 2 - ERV only,
---	---	---------------------------	---	---	--

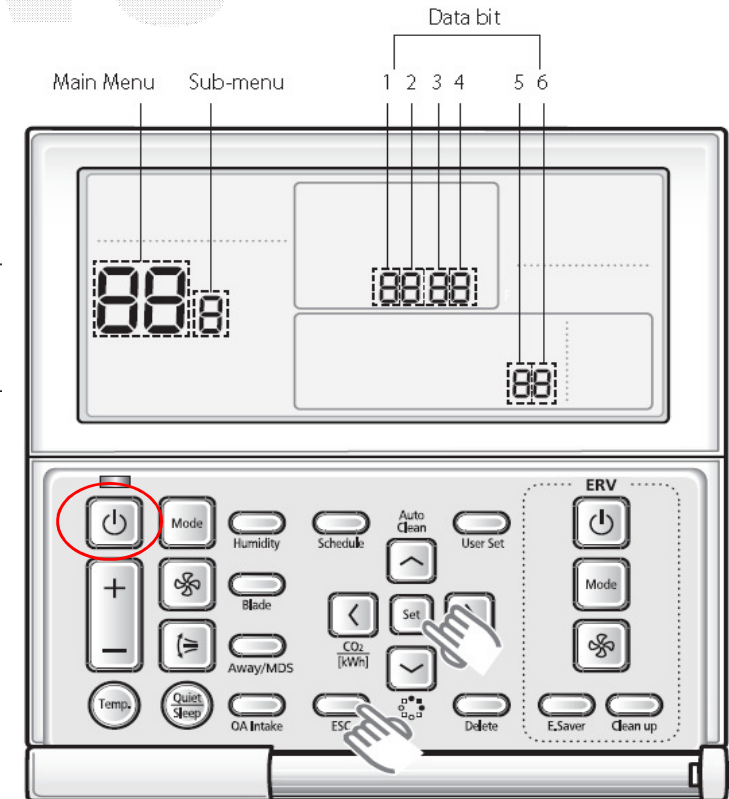

Application

■ Wired remote controller setting

- ✓ Service mode (MWR-WE10N)

1	4	ERV option Setting/checking	Use of By-Pass mode	1	0	0 - No use, 1 - Use	-
			Use of Auto mode	2	0	0 - No use, 1 - Use	-
			Use of air purification mode	3	0	0 - No use, 1 - Use	-
			Use of external control	4	0	0 - No use, 1 - Use	-

- Default mode without setting : Heat-EX mode, Quiet mode, Away mode

* Air purification mode is not available.

- Use of external control : Just display **External** LCD to notice external control may working.

→ To control the ERV by external contact, please set the ERV installation option.(SEG14)

Application

■ E. Saver

✓ Service mode (MWR-WE10N)

1	8	Set/CheckERV Energy saving operation	Select individual Energy saving operation	1	0	0-ON/OFF alternating operation, 1-Outdoor air cooling operation for different temperature setting	-
			Minimum temperature of outdoor air cooling	3,4	15	5 ~ 15 °C (41~59 °F)	°C

1. ERV only Installation

- Seg 1 : To select operation mode of Energy saving when **only ERV** is installed.

0 (On/Off alternation) : 30 mins on – 30 mins off repeating

2. ERV + IDU Installation

Seg 3,4 : The temperature range can be varied 5~ 15°C. (Refer to the next page)

Bypass or Heat exchanger mode operation according to condition

Prerequisite condition

- No option setting of central control (02 Series, SEG5)
- Hood mode : Off
- Indoor unit and ERV : On
- No fan mode of Indoor unit

Application

■ E. Saver

1) Cooling operation

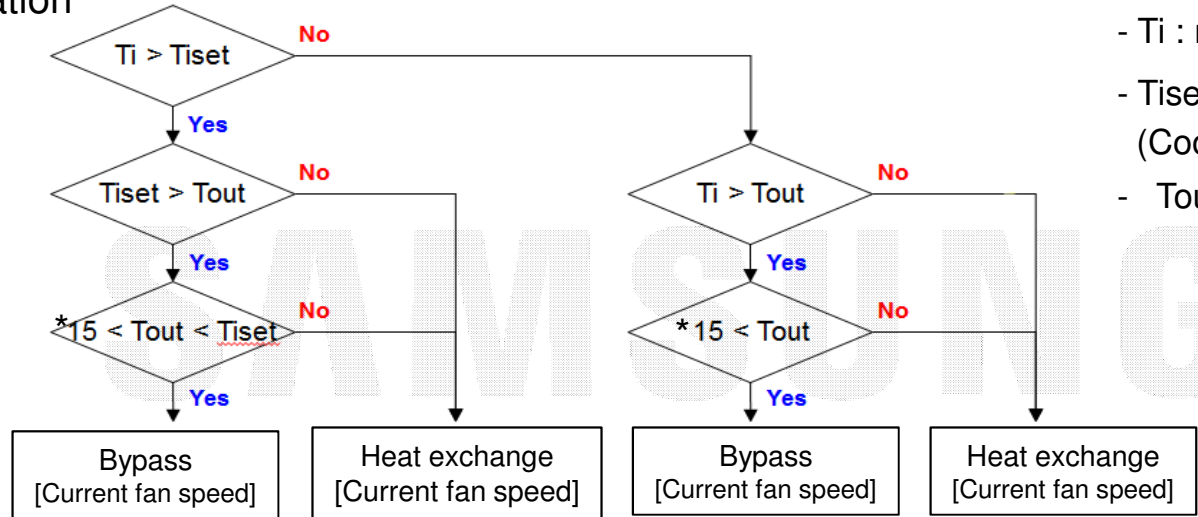

- Ti : room temp.
- Tiset : Set temp. of room
(Cooling : 26°C, heating : 22 °C)
- Tout : Outdoor temperature

* The range of can be varied from 5 to 15°C.

2) Heating operation

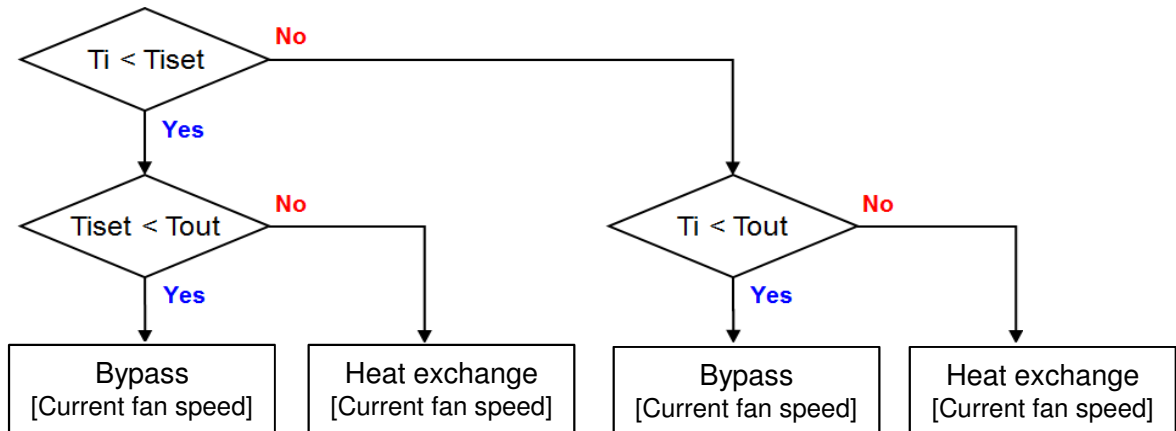

SAMSUNG

15552635

Samsung Electronics

THANK YOU